

クレーン部主仕様

クレーン仕様		84m仕様	50m仕様
吊上荷重		550ton×2.7m	←
メインブーム長さ		16.1~84m	16.1~50m
補助ジブ	固定式(フルタイプ)	14~56m	←
	起伏式	21~91m	←
メインブーム伸縮段数		7段	4段
カウンターウエイト		135/165ton	←
第1ウインチ	ラインプル	12.8ton	←
	巻上速度	0-130m/分	←
	ワイヤー長さ/径	620m/25mm	←
第2ウインチ	ラインプル	12.8ton	←
	巻上速度	0-145m/分	←
	ワイヤー長さ/径	620m/25mm	←
第3ウインチ (起伏ジブ用)	ラインプル	12.8ton	←
	巻上速度	0-130m/分	←
	ワイヤー長さ/径	1050m/25mm	←
最大地上揚程	メインブーム	84m	49m
	補助ジブ	140m	137m
旋回速度		0-1.0rpm	←
起伏速度(83度まで)		約70秒	←
ブーム伸縮速度		750秒	330秒

エンジン仕様

メーカー名	リープヘル社製
型式	D936L A6ディーゼル
冷却方式	水冷
シリンダー数	6
出力	326HP/1800rpm
最大トルク	151 kg-m/1200rpm

フック仕様

容量 (ton)	シーブ数
550	13×2
274	13
247.5	11
171	7
84.5	3
37	1
12.5	—

フックはオプション設定ですので上記の中からお選びください。

主寸法

外観寸法

単位：mm

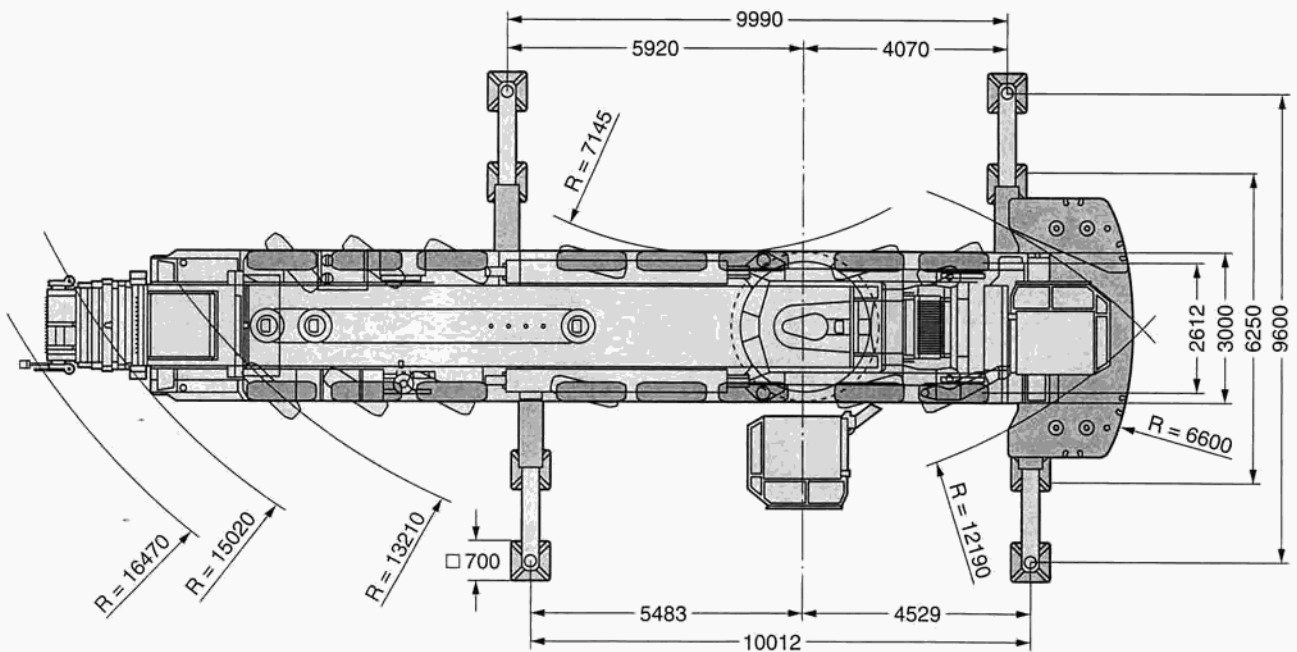
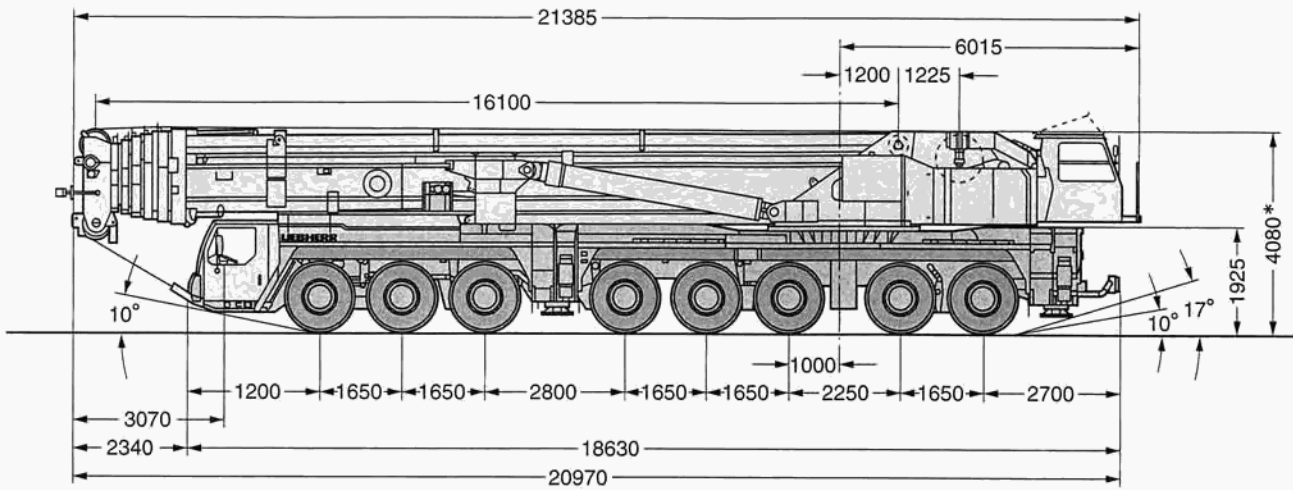

オールテレーンクレーン

図はメインブーム84m仕様ですが、
メインブーム50m仕様でも外形寸法は変わりません。
*クイックコネクション装備

本機は、公道を走行する場合、メインブーム及び旋回体を別
送としてクレーン台車のみで走行しなければなりません。



16.1m-84m



10m×9.6m



360°



135t

メインブーム 長さ 作業半径(m)	16.1m			21.3m	26.5m	31.7m	36.9m	42.1m	
	1)	2)	3)						
3	550	274	550	274					
3.5	440	274	440	274	274				
4	358	274	358	274	274	273			
4.5	288	274	288	274	274	263			
5	287	274	280	269	267	252	201		
6	254	254	248	237	235	229	184	159	
7	227	227	222	212	209	209	172	146	
8	205	205	200	190	187	187	160	135	
9	187	187	178	171	169	169	148	126	
10	171	171	159	155	152	152	137	117	
12	140	140	130	129	126	126	118	101	
14	118	118	110	109	106	106	102	88	
16					90	90	91	79	
18					78	78	78	71	
20					61	67	68	64	
22						59	60	58	
24						52	53	51	
26							46.5	45	
28							41.5	39.5	
30							36	35	
32								31	
34								27.8	
36									
38									
40									
ブーム 伸長率 (%)	I	0			46	46	92/46	92	92/46
	II	0			0	46	46/46	46	92/92
	III	0			0	0	0/46	46	46/92
	IV	0			0	0	0/0	0	0/0
	V	0			0	0	0/0	0	0/0
	VI	0			0	0	0/0	0	0/0

1) 後方吊り、165tカウンターウエイト

2) 360°、165tカウンターウエイト

3) 後方吊り、135tカウンターウエイト

TAB 218232,218234,218235.1/2



16.1m-84m



10m×9.6m



360°



135t

メインブーム 長さ 作業半径(m)	47.3m	52.5m	57.7m	62.9m	68.2m	73.4m	78.6m	84m
	8	102						
9	96	80						
10	90	76	66					
12	79	69	60	51	45			
14	70	63	54	47	41.5	36.5		
16	62	57	49.5	43	38.5	34	30	23
18	56	51	45.5	39.5	35.5	31.5	28.4	21.4
20	49.5	46	42	36.5	33	29.4	26.6	20
22	44	41.5	38.5	33.5	30.5	27.4	24.8	18.5
24	40.5	37	35	31	28.5	25.5	23.2	17.1
26	37.5	33.5	32	28.5	26.5	23.8	21.8	15.9
28	34.5	31	29.4	26.4	24.7	22.2	20.4	14.7
30	31.5	28.6	27.3	24.4	22.8	20.5	19.1	13.7
32	29.3	26.4	25.3	22.6	20.9	19.1	17.9	12.5
34	27	24.4	23.5	20.9	19.2	17.7	16.5	11.2
36	24.8	22.6	21.8	19.1	17.7	16.5	15.3	10.2
38	22.3	20.8	20.2	17.3	16.5	15.3	14.2	9.2
40	19.8	19.1	18.6	15.6	15.4	14.2	13.2	8.4
42	17.7	17.5	17.2	14.5	14.3	13.2	12.3	7.6
44	15.7	16	15.7	13.4	13.1	12.1	11.4	6.8
46	10.1	14.5	14.4	12.3	12	11.1	10.6	6
48		13	13.1	11.3	10.9	10.2	9.7	5.3
50		9.6	11.8	10.3	9.8	9.6	8.9	4.6
52			10.6	9.4	9	8.9	8.4	4.2
54			9.4	8.5	8.3	8.3	7.9	3.8
56			5.7	7.6	7.7	7.6	7.4	3.5
58				6.8	7	7	7	3.1
60				6	6.4	6.4	6.5	2.8
62					5.8	5.8	6	2.5
64					5.2	5.3	5.5	2.1
66					3.5	4.7	5	1.9
68						4.2	4.5	
70						3.7	4.1	
72							3.6	
74							3.2	
ブーム 伸長率 (%)	I	92/0	92/0	92/0	92/0	92/0	92	100
	II	92/0	92/0	92/92	92/46	92/92	92	100
	III	92/92	92/46	92/92	92/92	92/92	92	100
	IV	0/92	46/92	46/92	92/92	92/92	92	100
	V	0/46	0/92	46/46	46/92	46/92	92	100
	VI	0/46	0/92	0/46	0/92	46/92	46	92

TAB 218235.2/3

31.7m-84m 10m×9.6m 360° 165t Y-ガイ

メインブーム 作業半径(m)	長さ	31.7m	36.9m	42.1m	47.3m	52.5m	57.7m	62.9m	68.2m	73.4m	78.6m	84m
5		205										
6		200	169									
7		194	163									
8		185	158	129	123							
9		169	152	121	118	113						
10		154	144	117	114	109	96					
12		132	126	110	107	102	91	81				
14		114	109	104	101	96	86	78	70	62		
16		98	101	93	95	90	81	74	67	59	52	44
18		88	89	83	85	81	76	70	64	57	49.5	42.5
20		81	81	80	77	75	72	66	61	55	47.5	40.5
22		72	72	71	72	68	67	63	58	52	45.5	38.5
24		64	65	63	65	63	62	59	54	49	44	37
26		58	60	59	58	59	57	55	51	47.5	42	35.5
28		52	54	54	55	54	52	52	47.5	44.5	40.5	34
30		40.5	49.5	49	50	48.5	48.5	47.5	45.5	43.5	39	32.5
32			40.5	41	46	44.5	44.5	43.5	43	39.5	37.5	31
34				37.5	42.5	41.5	41.5	40.5	40	36.5	35.5	29.8
36				34.5	39	37.5	36.5	36.5	37.5	34	34	28.5
38				27.1	33	31.5	30.5	30.5	31.5	28.6	27.2	26.2
40					30.5	29	29	28.1	29.2	26.4	25.1	24.1
42					27.2	26.8	26	25.9	27	24.2	23	22.9
44					16.7	24.8	23.9	23.8	24.9	22.1	21.4	21.3
46						22.9	24	22	23	20.3	19.6	19.7
48						17.6	22.3	20.2	21.3	18.5	18	18.2
50							20.7	18.6	19.7	16.9	16.5	16.8
52							17.8	17.2	18.2	14.1	15.2	15.4
54							11.8	15.8	16.9	12.8	13.9	14.1
56								13.9	15.6	11.5	12.7	12.9
58								10.2	14.4	10.3	11.4	11.8
60									13.3	9.1	10.2	10.8
62										7.9	9.1	9.8
64										6.5	8	8.9
66											7	8
68											5.9	7.2
70											4.5	6.4
72												5.5
74												4.2
76												
78												
ブーム 伸長率 (%)		I 46/0 II 46/0 III 46/0 IV 0/0 V 0.92 VI 0.46	I 92/0 II 46/0 III 46/0 IV 0/0 V 0.92 VI 0.92	I 92/0 II 92/0 III 46/0 IV 0/92 V 0.92 VI 0.46	I 92/0 II 92/0 III 92/0 IV 0.92 V 0.92 VI 0.92	I 46/0 II 92/0 III 92/92 IV 46/92 V 46/92 VI 0.46	I 0/0 II 92/0 III 92/92 IV 92/92 V 46/92 VI 46/92	I 92/0 II 92/92 III 92/92 IV 92/92 V 46/92 VI 0.46	I 92/0 II 92/92 III 92/92 IV 92/92 V 46/92 VI 46/92	I 92 II 92 III 92 IV 92 V 92 VI 46	I 92 II 92 III 92 IV 92 V 92 VI 92	I 100 II 100 III 100 IV 100 V 100 VI 100

TAB 218020

31.7m-84m 10m×9.6m 360° 135t Y-ガイ

メインブーム 作業半径(m)	長さ	31.7m	36.9m	42.1m	47.3m	52.5m	57.7m	62.9m	68.2m	73.4m	78.6m	84m
5		205										
6		200	169									
7		194	163									
8		185	158	129	123							
9		169	152	121	118	113						
10		154	144	117	114	109	96					
12		127	126	110	107	102	91	81				
14		107	108	104	101	96	86	78	70	62		
16		97	96	90	93	90	81	74	67	59	52	44
18		86	86	83	82	80	76	70	64	57	49.5	42.5
20		75	75	76	75	71	71	66	61	55	47.5	40.5
22		66	68	68	67	67	63	63	58	52	45.5	38.5
24		59	61	61	62	60	59	57	53	50	44	37
26		52	55	54	56	54	55	51	50	47	42	35.5
28		47	49.5	49	50	48.5	50	47	47	42.5	40.5	34
30		40.5	44.5	44	45.5	44	45	42.5	43	39	39	32.5
32			40.5	40	41.5	40	41	39	39.5	35.5	36	31
34			37	36.5	38	36.5	37.5	35.5	36	32.5	33	29.8
36				33	35	33	34	32	33	29.6	30	28.5
38				30.5	32	30	31.5	29.3	30.5	27	27.6	27.2
40				27.1	29.3	27.6	28.8	26.7	27.8	24.7	25.4	25
42					26.9	25.3	26.4	24.3	25.4	22.6	23.3	23
44					24.8	23.2	24.3	22.2	23.3	20.5	21.5	21.2
46					16.7	21.2	22.4	20.3	21.4	18.6	19.7	19.5
48						19.5	20.7	18.5	19.6	16.8	17.9	18
50						17.6	19.1	16.9	18	15.2	16.3	16.5
52							16.2	14.1	15.4	13.7	14.8	15.1
54							11.8	12.8	14.1	12.4	13.5	13.7
56								10.2	12.8	11.1	12.2	12.4
58									11.6	9.9	11	11.2
60									11.6	8.8	9.9	10.1
62									10.6	7.8	8.9	9.1
64									9.6	6.8	7.9	8.1
66										6	7	7.2
68										5.2	6.2	6.4
70											5.4	5.5
72											4.8	5
74											4.2	4.4
76												3.8
78												3.1
ブーム 伸長率 (%)		I 46/0 II 46/0 III 46/0 IV 0.92 V 0.46 VI 0/0	I 92/0 II 46/0 III 46/0 IV 0/0 V 0.92 VI 0.92	I 92/0 II 92/0 III 46/0 IV 0/92 V 0.92 VI 0.46	I 92/0 II 92/0 III 92/0 IV 0.92 V 0.92 VI 0.92	I 0/0 II 92/0 III 92/92 IV 92/92 V 46/92 VI 0.46	I 0/0 II 92/0 III 92/92 IV 92/92 V 46/92 VI 46/92	I 92/0 II 92/92 III 92/92 IV 92/92 V 46/92 VI 0.46	I 92/0 II 92/92 III 92/92 IV 92/92 V 46/92 VI 46/92	I 92 II 92 III 92 IV 92 V 92 VI 46	I 92 II 92 III 92 IV 92 V 92 VI 92	I 100 II 100 III 100 IV 100 V 100 VI 100

TAB 218021

オールテレーンクレーン

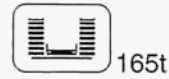

メインブーム長さ		16.1m+4m*										26.5m+4m*											
ジブ長さ		21m	28m	35m	42m	49m	56m	63m	70m	77m	84m	91m	21m	28m	35m	42m	49m	56m	63m	70m	77m	84m	91m
22	49.5																						
24	46																						
26	43.5												54										
28	43.5												50										
30													47.5	45.5									
32													45.5	42.5									
34														40.5									
36														38.5	36.5								
38														37	35	33.5							
40														34.5	33	32							
42															32	30.5	28.8						
44															30	29.5	27.4						
46															28.6	27.9	26.1	24.5					
48																26.5	25.4	23.4					
50																25.2	24.2	22.4	20.8				
52																23.9	23	21.8	20				
54																22.8	21.9	21.2	19.2	17.6			
56																	20.9	20.2	18.7	17			
58																	19.9	19.2	18.2	16.4	15.2		
60																	19	18.3	17.6	15.9	14.7		
62																		17.5	16.8	15.4	14.2	13	
64																		16.7	16	15	13.7	12.6	
66																		16	15.3	14.5	13.2	12.2	10.6
68																		15.3	14.6	14	12.7	11.9	10.3
70																		13.9	13.4	12.2	11.4	10	
72																		13.3	12.8	11.9	11	9.7	
74																		12.8	12.2	11.3	10.6	9.3	
76																			11.6	10.8	10	9	
78																			11.1	10.2	9.5	8.6	
80																			10.6	9.7	8.9	8.1	
82																			10.1	9.2	8.4	7.6	
84																				8.8	8	7.1	
86																				8.3	7.5	6.6	
88																				7.9	7.1	6.2	
90																					6.7	5.7	
92																					6.3	5.4	
94																					5.9	5.2	
96																					5.6	5	
98																						4.8	
100																							4.5
ブーム伸長率 (%)																							
I																							46
II																							46
III																							0
IV																							0
V																							0
VI																							0

*アダプター

TAB 218253.1/2



メインブーム長さ		36.9m+4m*										47.3m+4m*							57.7m+4m*				68.2m				
ジブ長さ		21m	28m	35m	42m	49m	56m	63m	70m	77m	84m	91m	21m	28m	35m	42m	49m	56m	63m	70m	21m	28m	35m	42m	+4m*	42m	
32	33.5																										
34	31.5																										
36	29.8												18.8														
38													17.5														
40													16.3	15.1													
42														14.1													
44														13.1	12.5												
46														12.2	11.6												
48														11.6	10.9	9.9											
50															9.2	8.5	7.3										
52															7.9	6.7											
54															6.8	5.7	4.8										
56															6.4	5.2	4.1	3.2									
58															6.1	4.8	3.8	2.9									
60																4.6	3.5	2.5	1.7								
62																4.4	3.2	2.3	1.4								
64																4.2	3	2.3	1.2								
66																	2.8	1.8	1								
68																	2.6	1.6									
70																	2.4	1.4									
72																	2.2	1.3									
74																		1.1									
76																											
78																											
80																											
82																											
84																											
86																											
88																											
90																											
92																											
94																											
96																											
98																											
100																											
104																											
ブーム伸長率 (%)																											
I																											
II																											
III																											
IV																											
V																											
VI																											

*アダプター

TAB 218253.3/4

オールテレーンクレー

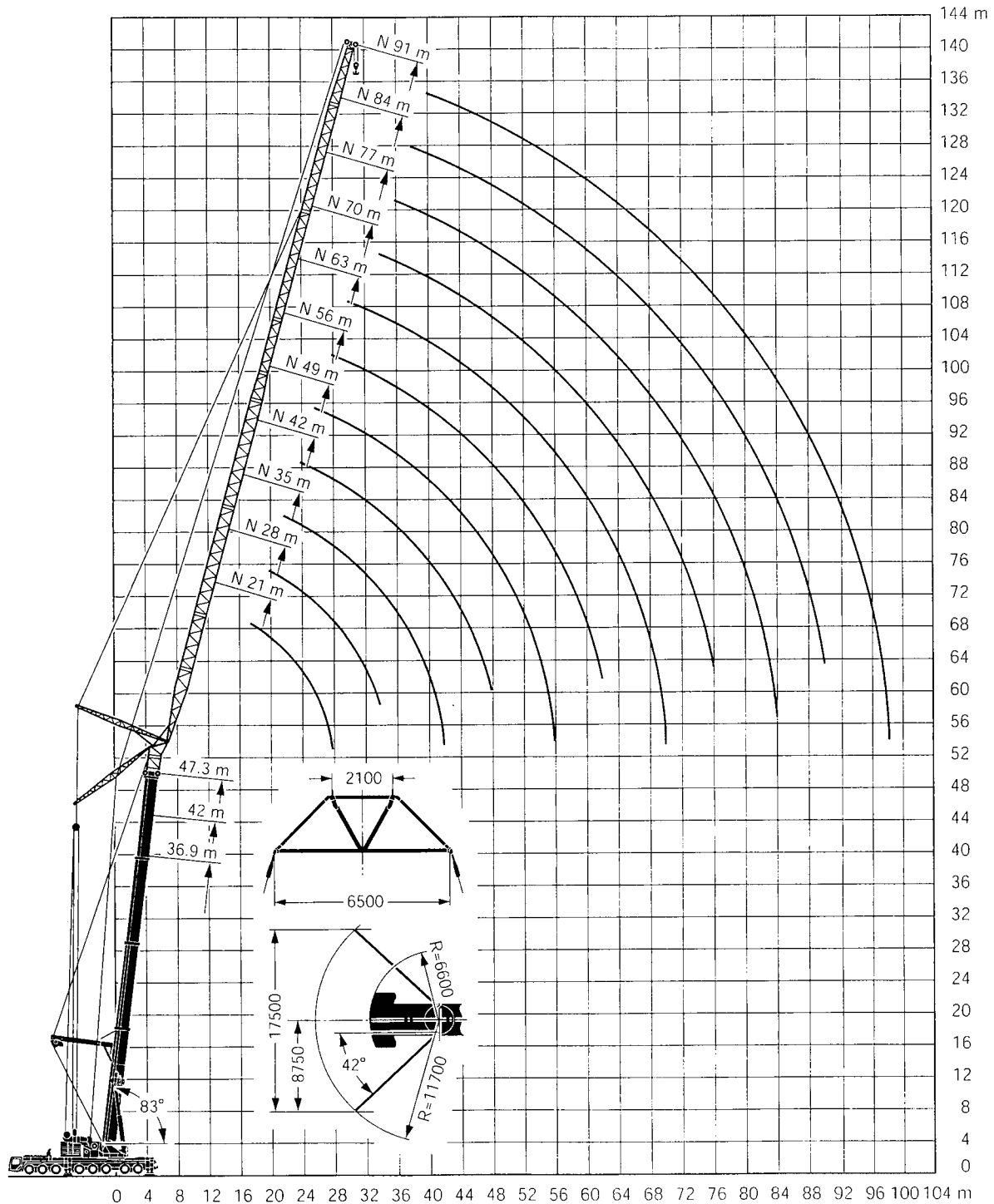

オールテレーンクレーン

注意

- 1 定格総荷重はフックブロック、玉掛ワイヤー等の自重を含みます。
また、下記の条件が考慮されていないのでクレーンの操作には充分気をつけてください。
 - ① 地盤の強度、地震による影響
 - ② 作業速度に応じた動荷重および台風または強風による影響等
- 2 本機は水平に設置して、クレーン作業を行ってください。
- 3 作業半径は、クレーンの旋回中心から荷重の重心までの水平距離です。
- 4 メインブームの定格総荷重は補助ジブを取り除いた状態での値です。
- 5 メインブーム84m仕様で262トンを超える定格総荷重の場合は、特殊吊装置が必要です。

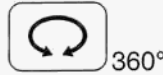
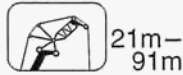

メインブーム長さ		36.9m+4m*										47.3m+4m*											
ジブ長さ		21m	28m	35m	42m	49m	56m	63m	70m	77m	84m	91m	21m	28m	35m	42m	49m	56m	63m	70m	77m	84m	91m
32	40.5																						
34	38																						
36	35.5																						
38	32.5																						
40	30.5	29.7																					
42	28.8	28																					
44	27.3	26.5	25.9																				
46		25.1	24.5																				
48		23.8	23.2	22.5																			
50		22.6	22	21.3																			
52			20.9	20.2	19.7																		
54			19.9	19.2	18.7																		
56			18.9	18.3	17.7	17																	
58			18.1	17.4	16.9	16.2																	
60				16.6	16.0	15.4	15																
62				15.8	15.3	14.6	14.2																
64				15.1	14.6	13.9	13.5	12.8															
66					13.9	13.3	12.9	12.2															
68						13.3	12.6	12.3	11.5	10.9													
70						12.7	12.1	11.7	11	10.4													
72					12.1	11.5	11.1	10.4	9.8	9.2													
74						11	10.6	9.9	9.3	8.7													
76							10.5	10.1	9.4	8.8	8.2												
78								9.6	8.9	8.3	7.7												
80									9.2	8.5	7.9	7.3											
82									8.8	8.1	7.5	6.9											
84									8.4	7.7	7.1	6.5											
86									8	7.3	6.7	6.1											
88										6.9	6.4	5.8											
90										6.6	6	5.5											
92										6.3	5.7	5.2											
94											5.4	5											
96												5.2	4.7										
98												5	4.5										
100												4.8	4.3										
104													3.9										
108																							
ブーム伸長率 (%)	II							92															
	III							46															
	IV							46															
	V							0															
	VI							0															

*アダプター

TAB 218262.1/2

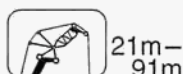

メインブーム長さ		57.7m+4m*										68.2m+4m*					78.6m+4m*			
ジブ長さ		21m	28m	35m	42m	49m	56m	63m	70m	77m	21m	28m	35m	42m	49m	56m	21m	28m	35m	
42	22.6																			
44	21.3																			
46		19.4																		
48		18.3																		
50		17.3	16.3																	
52		16.4	15.4																	
54			14.6	14.1																
56			13.9	13.3																
58			13.2	12.6	11.7															
60				12	11.1															
62				11.4	10.5	9.7														
64				10.8	9.9	9.2														
66				10.3	9.4	8.7	6.2													
68					8.9	8.2	5.9													
70					8.4	7.8	5.5	3.6												
72					8	7.4	5.2	3.3												
74						7	4.9	3.1	1.9											
76						6.6	4.6	2.9	1.7											
78						6.2	4.3	2.6	1.5											
80						6	4.1	2.4	1.3											
82							3.9	2.2	1.1											
84							3.6	2	1											
86							3.4	1.8												
88								1.6												
90								1.3												
92								1.3												
94								1.2												
ブーム伸長率 (%)	II							92												
	III							92												
	IV							92												
	V							46												
	VI							46												

*アダプター

TAB 218262.3/4

オールテレーンクレーン

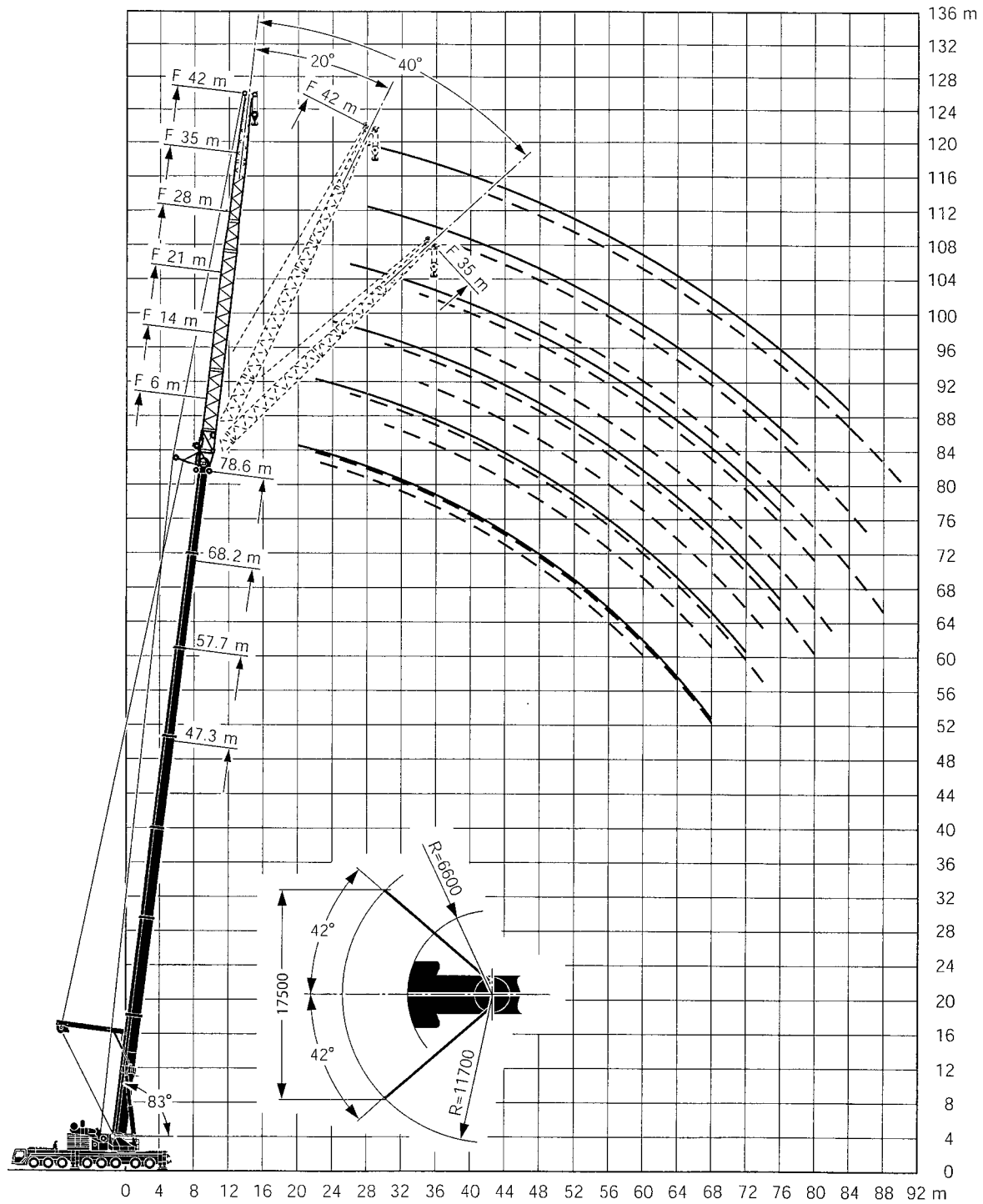

オールテレーンクレーン

注意

- 1 定格総荷重はフックブロック、玉掛ワイヤー等の自重を含みます。
また、下記の条件が考慮されていませんのでクレーンの操作には充分気をつけてください。
 - ① 地盤の強度、地震による影響
 - ② 作業速度に応じた動荷重および台風または強風による影響等
- 2 本機は水平に設置して、クレーン作業を行ってください。
- 3 作業半径は、クレーンの旋回中心から荷重の重心までの水平距離です。
- 4 メインブームの定格総荷重は補助ジブを取り除いた状態での値です。
- 5 メインブーム84m仕様で262トンを超える定格総荷重の場合は、特殊吊装置が必要です。

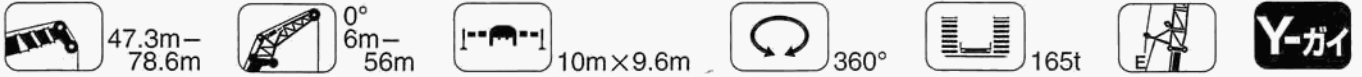

作業半径(m)	47.3m+2.2m*								57.7m+2.2m*							
	6m	14m	21m	28m	35m	42m	49m	56m	6m	14m	21m	28m	35m	42m	49m	56m
9	102															
10	100															
12	96	81	59						90							
14	92	76	55	41.5					85	74						
16	82	71	51	39	31.5	26			76	70	51	39				
18	73	67	48	36.5	29.4	24.4	19.6		68	65	48.5	37	28.6	23.7		
20	66	63	45.5	34.5	27.7	23.4	18.4	14.9	62	59	46	35	28.6	23.4	17.8	
22	60	56	43	32.5	26	21.7	17.4	14.1	56	54	43.5	33	25.8	21.3	16.9	13.7
24	55	53	40.5	30.5	24.7	20.5	16.5	13.3	51	49	41.5	31.5	24.6	20.3	16.1	13.2
26	49.5	48.5	38.5	29.1	23.4	19.5	15.5	12.6	47	45	40	30	23.4	19.3	15.4	12.6
28	44	45	37	27.8	22.1	18.5	14.8	11.9	43	41.5	38	28.9	22.4	18.4	14.6	12.6
30	39	40.5	35	26.5	21.2	17.5	14.1	11.3	39.5	38.5	36.5	27.5	21.4	17.6	13.9	12
32	35	37	33.5	25.2	20.2	16.7	13.3	10.7	36	35.5	34.5	26.5	20.4	16.9	13.3	11.4
34	31	33.5	32	24	19.3	16	12.7	10.1	32.5	33	32	25.5	19.6	16.1	12.8	10.9
36	27.7	30	30.5	23	18.4	15.2	12.1	9.6	29.2	29.8	29.9	24.5	18.9	15.4	12.2	10.4
38	24.6	26.5	28.4	22.1	17.6	14.5	11.6	9.1	26.3	27.1	27.5	23.5	18.2	14.9	11.6	10
40	21.6	24.2	25.9	21.1	16.9	13.8	11.1	8.7	23.6	24.7	25.1	22.6	17.5	14.3	11.2	9.5
42	19.4	21.7	23.4	20.2	16.2	13.3	10.5	8.3	21.1	22.4	23	21.9	16.8	13.7	10.8	9.1
44	17.2	19.4	21.1	19.4	15.5	12.8	10	7.9	18.9	20.4	21	21.2	16.2	13.2	10.3	8.7
46	15.1	17.4	19.1	18.7	14.8	12.3	9.6	7.5	16.8	18.3	19.2	19.6	15.6	12.6	9.9	8.4
48	13.3	15.5	17.2	17.9	14.3	11.7	9.2	7.1	15	16.5	17.5	17.9	15.1	12.2	9.5	8
50	11.1	13.8	15.5	16.7	13.7	11.2	8.8	6.8	13.2	14.7	15.9	16.4	14.6	11.8	9.1	7.7
52	7	12.2	13.9	15.1	13.2	10.8	8.4	6.5	11.3	13.2	14.3	15	14.1	11.4	8.8	7.3
54		10.7	12.4	13.6	12.6	10.3	8	6.2	9.7	11.7	12.8	13.6	13.6	11	8.5	7
56		9.4	11	12.2	12	9.9	7.7	5.8	8.1	10.3	11.5	12.4	13	10.6	8.2	6.7
58		7.1	9.7	10.9	11.6	9.4	7.3	5.5	6.5	9.1	10.2	11.1	11.9	10.2	7.9	6.5
60			7.4	8.8	9.8	7.7	5.2	5.2	4.9	7.9	9.1	10.8	11.8	10.8	7.6	6.2
62			5.6	6.6	7.6	5.7	4.5	4.5	4.5	6.8	7.9	9.7	10.8	9.7	7.3	5.7
64			3.5	4.6	5.6	3.7	2.9	2.9	2.9	5.7	6.8	8.8	9.7	9.4	7	5.4
66				2.8	3.8	4.8	3.1	3.1	3.1	4.6	5.9	7.7	8.7	8.1	6.7	5.4
68					2.8	3.8	4.8	3.1		3.3	4.5	5.9	6.8	7.2	6.4	5.2
70						2.5	2.5	2.5		3	4.4	5.1	5.9	6.4	5.1	4
72											3.3	4.5	5.2	5.5	5.8	4.8
74												2.1	3.8	4.6	5.4	4.6
76													3.1	4	4.8	4.4
78														2.2	3.7	4.2
80															3.1	3.6
82																3
84																2.5
86																1.9
88																2.4
90																1.5
ブーム伸長率 (%)	I				92									92		
	II				92									92		
	III				92									92		
	IV				92									92		
	V				92									92		
	VI				92									92		

*アダプター

TAB 218110

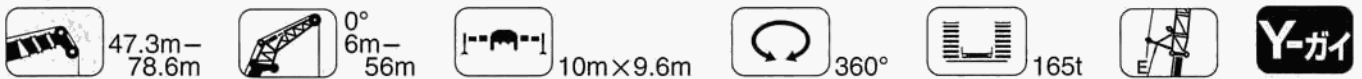

作業半径(m)	68.2m+2.2m*								78.6m+2.2m*							
	6m	14m	21m	28m	35m	42m	49m	56m	6m	14m	21m	28m	35m	42m		
16	66															
18	61	53														
20	57	50	42.5	32.5					38.5							
22	52	47.5	40.5	31	24.9				36.5	30.5						
24	48	44.5	38.5	29.7	23.8	18.9			34.5	29	24.2					
26	44	42	36.5	28.6	22.9	18.1	14.2		32.5	27.8	23.1	18.7				
28	40.5	39	34.5	27.4	22	17.4	13.6	11.6	30.5	26.5	22.1	17.9	15.2	13.7		
30	37.5	36	33	26.4	21.1	16.7	13	11.1	28.1	25.4	21.2	17.2	14.5	13.5		
32	34.5	33.5	31	25.5	20.4	16	12.5	10.6	25.9	24.4	20.3	16.4	13.9	13		
34	31	31	29.6	24.6	19.7	15.4	12	10.2	24.2	23.4	19.5	15.7	13.4	12.5		
36	28	28.8	28	23.8	19	14.9	11.6	9.8	22.5	22.3	18.7	15.1	12.8	12		
38	25.5	26.8	26.1	22.9	18.3	14.4	11.1	9.4	20.8	21.2	18	14.5	12.2	11.5		
40	23	24.5	24.4	22	17.7	13.8	10.7	9	19.1	20.1	17.3	13.9	11.8	11		
42	20.5	22.4	22.6	21.1	17.2	13.4	10.3	8.7	17.7	19	16.6	13.3	11.3	10.6		
44	18.3	20.5	20.7	20.2	16.6	12.9	9.9	8.3	16.4	17.9	16	12.9	10.8	10.2		
46	16.5	18.7	19	19.1	16.1	12.5	9.6	8	15.2	16.7	15.4	12.4	10.4	9.8		
48	14.7	17	17.4	17.6	15.6	12.1	9.3	7.6	14	15.6	14.8	11.9	10	9.4		
50	12.9	15.4	15.9	16.1	15.1	11.7	9	7.4	12.8	14.6	14.1	11.5	9.6	9		
52	11.1	14	14.5	14.8	14.5	11.3	8.7	7.1	11.5	13.4	13.2	11	9.2	8.7		
54	9.7	12.5	13.2	13.5	13.6	10.9	8.4	6.9	10.2	12.3	12.3	10.5	8.9	8.4		
56	8.3	10.9	12	12.3	12.5	10.4	8.1	6.6	9	11.2	11.3	9.8	8.5	8.1		
58	7	9.4	10.8	11.2	11.4	9.9	7.8	6.4	7.7	10	10.4	9	8.1	7.7		
60	5.6	8.3	9.4	10.2	10.4	9.5	7.5	6.1	6.4	8.8	9.5	8.3	7.6	7.4		
62	4.3	7.1	8.1	9.2	9.4	9	7.3	5.9	5.3	7.6	8.5	7.5	7.1	7.1		
64	3.2	5.9	6.9	8.2	8.5	8.5	7.1	5.7	4.3	6.4	7.5	6.8	6.6	6.9		
66	2	4.7	5.9	7.3	7.7	7.7	6.9	5.5	3.3	5.2	6.4	6	6.1	6.6		
68		3.6	4.9	6.2	6.8	6.9	6.6	5.3	2.3	4.2	5.4	5.2	5.6	6.4		
70		2.7	3.8	5.3	6	6.2	6.4	5.1		3.4	4.3	4.4	5.1	6.1		
72		2	2.8	4.4	5.3	5.4	5.7	4.9		2.5	3.3	3.6	4.3	5.5		
74			1.8	3.5	4.6	4.8	5	4.7		1.6	2.8	2.8	3.6	4.9		
76				2.6	4	4.1	4.4	4.3			2.2	2.2	2.8	4.2		
78				1.7	3.2	3.5	3.8	3.7			1.7	2	2	3.6		
80					2.4	2.9	3.2	3.1						3.1		
82					1.6	2.3	2.6	2.6						2.5		
84						1.8	2.1	2.1						2		
86							1.6	1.5						1.7		
ブーム伸長率 (%)	I				92									92		
	II				92									92		
	III				92									92		
	IV				92									92		
	V				92									92		
	VI				92									92		

*アダプター

TAB 218110

オールテレーンクレーン

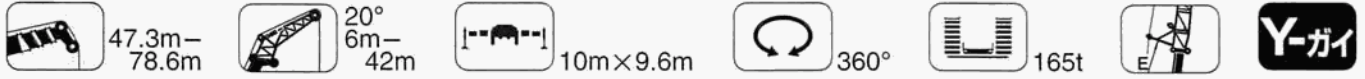

作業半径(m)	47.3m+2.2m*						57.7m+2.2m*					
	6m	14m	21m	28m	35m	42m	6m	14m	21m	28m	35m	42m
12	72											
14	67						68					
16	63	45					65					
18	60	44.5					62	44.5				
20	56	42.5	27.2				59	43				
22	54	41	27				56	41.5	27.2			
24	51	39.5	26.7	17.9			52	40	27.2			
26	49	38	26.3	17.6	13.7		47.5	39	27.2	18.3		
28	45.5	37	25.7	17.4	13.7		44	38	27.2	18.2		
30	40.5	36	25.1	17.1	13.7		40.5	36.5	26.7	18.1		
32	36	34.5	24.3	16.9	13.7	11.3	37	36.5	26.7	18.1		
34	32.5	34	23.5	16.7	13.7	11	33.5	34.5	25.7	17.8	13.7	11.1
36	28.7	32.5	22.8	16.5	13.7	10.7	30.5	32	24.3	17.6	13.7	11
38	25.6	29.2	22.2	16.3	13.7	10.5	27.3	29.5	23.6	17.4	13.7	10.8
40	22.7	26.3	21.5	16.1	13.3	10.2	24.5	26.8	23	16.9	13.7	10.6
42	20.2	23.6	20.9	15.8	12.9	10	22	24.2	22.4	16.5	13.3	10.4
44	17.8	21.2	20.4	15.4	12.5	9.7	19.7	22.2	21.9	16	13	10
46	15.7	19	19.9	14.9	12.1	9.3	17.5	20.1	21.4	15.6	12.6	9.7
48	13.7	16.9	19.4	14.5	11.7	9	15.6	18.1	19.9	15.2	12.3	9.4
50		15	17.6	14.1	11.3	8.6	13.8	16.2	18.1	14.8	11.9	9.1
52		13.3	15.8	13.8	11	8.3	12.2	14.5	16.4	14.5	11.6	8.8
54		11.7	14.1	13.4	10.6	8	10.4	12.9	14.8	14.1	11.3	8.5
56		10.2	12.6	13.1	10.3	7.7	8.7	11.4	13.3	13.7	11	8.2
58			11.1	12.8	10	7.4	7.1	10.1	11.9	13.3	10.7	7.9
60			9.8	11.7	9.8	7.2		8.8	10.6	12.1	10.4	7.7
62			8.5	10.4	9.5	7		7.6	9.3	10.9	10.1	7.4
64			7.2	9.2	9.3	6.8		6.6	8.2	9.7	9.9	7.2
66				8	9.1	6.6		5.4	7.1	8.6	9.7	7
68				6.9	8.7	6.3			6	7.5	8.6	6.8
70				5.8	7.6	6.2			5.1	6.5	8	6.6
72					6.6	6			4.4	5.5	7	6.5
74					5.6	5.9				4.8	6.1	6.3
76					4.9	5.7				4.1	5.3	6.1
78					4.2	5.2				3.4	4.6	5.4
80						4.6				2.6	4	4.8
82						3.9					3.3	4.2
84						3.2					2.6	3.6
86											1.8	2.9
88												2.2
90												1.5
ブーム伸長率 (%)	92						92					
	92						92					
	92						92					
	46						46					
	0						0					

*アダプター

TAB 218119

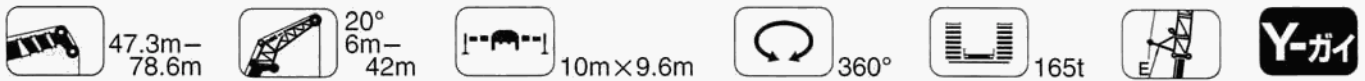

作業半径(m)	68.2m+2.2m*						78.6m+2.2m*					
	6m	14m	21m	28m	35m	42m	6m	14m	21m	28m	35m	42m
18	60											
20	57											
22	53						34.5					
24	49	40					33					
26	45	39	27.2				31.5	25.1				
28	41.5	38	26.9				30	24.1				
30	38	36.5	26.1	17.9			28.5	23.2	18.6			
32	35.5	34.5	25.4	17.1			26.9	22.3	18.1			
34	33	32.5	24.7	17.8	13.7		25.2	21.5	17.6	11.6		
36	29.8	30	24.1	17.6	13.7		23.4	20.7	17	11.4		
38	27	28.1	23.5	17.3	13.7	10.7	21.6	20	16.3	11.2	8.9	
40	24.3	26.1	23	16.8	13.6	10.6	19.8	19.3	15.8	11.1	8.7	
42	21.6	24.4	22.5	16.4	13.3	10.3	18.4	18.7	15.3	10.9	8.6	7.3
44	19.6	22.3	22	16	13	10	17	18	14.7	10.8	8.4	7.2
46	17.6	20.4	21.3	15.6	12.6	9.7	15.7	17.4	14.2	10.6	8.3	7
48	15.5	18.6	19.8	15.3	12.3	9.4	14.4	16.8	13.8	10.5	8.1	6.9
50	13.6	17	18.2	14.9	12	9.1	13.1	16	13.4	10.3	8	6.8
52	12	15.4	16.2	14.6	11.7	8.9	11.8	14.9	12.9	10	7.9	6.6
54	10.5	14	15.2	14.3	11.4	8.6	10.6	13.9	12.5	9.7	7.8	6.5
56	8.9	12.5	13.9	13.9	11.2	8.4	9.3	12.8	11.9	9.4	7.6	6.4
58	7.4	11.2	12.6	13.6	10.9	8.1	8.1	11.7	11.3	9.1	7.4	6.3
60	6.1	9.9	11.4	12.4	10.7	7.9	6.9	10.5	10.6	8.7	7.2	6.1
62	4.8	8.7	10.2	11.3	10.4	7.7	5.7	9.3	10	8.3	7	6.1
64	3.6	7.4	9	10.3	10.2	7.5	4.6	8	9.4	7.8	6.9	5.9
66	2.3	6.2	8	9.2	10	7.3	3.4	6.7	8.4	7.3	6.7	5.8
68		4.9	7	8.2	9.2	7.1	2.5	5.4	7.4	6.8	6.4	5.7
70		3.7	6	7.2	8.3	6.9	1.8	4.4	6.3	6.3	6.1	5.6
72		2.7	4.9	6.3	7.3	6.7		3.4	5.2	5.7	5.8	5.5
74		1.7	3.8	5.4	6.4	6.5		2.5	4.2	4.8	5.5	5.3
76			2.6	4.8	5.6	6.2			3.3	4	5.2	5.1
78			1.9	3.8	4.9	5.5			2.6	3.2	4.7	4.9
80				2.8	4.3	4.9				2	4	4.7
82				1.8	3.7	4.3				1.6	3.2	4.5
84					3	3.6					2.5	3.9
86					2.2	3					1.7	3.3
88					2.2	2.4						2.7
90						1.8						2
92												1.3
ブーム伸長率 (%)	92						92					
	92						92					
	92						92					
	46						46					
	0						0					

*アダプター

TAB 218119

オールテレーンクレーン

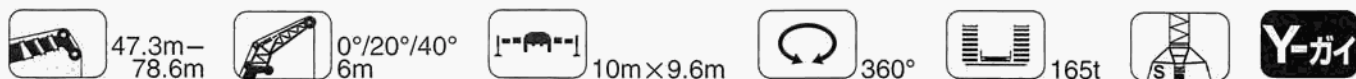

メインブーム長さ		47.3m+2.2m*			57.7m+2.2m*			68.2m+2.2m*		
ジブ長さ		6m			6m			6m		
角度		0°	20°	40°	0°	20°	40°	0°	20°	40°
作業半径(m)										
9		119								
10		113								
12		100	70	42	87					
14		89	66	40.5	78	66	40.5	66		
16		81	61	39	71	62	39.5	61	60	
18		73	58	37.5	65	59	38	56	56	38.5
20		66	54	36.5	60	56	37	52	53	37.5
22		59	51	35	55	54	36	48.5	49	36.5
24		54	48	34	50	51	35	45	45.5	35.5
26		49	45.5	33.5	45.5	47	34	42	42.5	35
28		43.5	43.5	32.5	42	43.5	33.5	39	39.5	34
30		39	40	31.5	39	40	32.5	36	37	33.5
32		34.5	36	31	35.5	37	32	33.5	34.5	33
34		31	32	30.5	32	33.5	31.5	31	32	32
36		27.4	28.5	29.1	29	30	31	28.8	29.8	30.5
38		24.4	25.5	25.9	26.2	27.2	27.8	26.7	27.7	28.5
40		21.6	22.5	22.9	23.4	24.3	24.9	24.2	25.2	25.9
42		19.2	19.9		20.9	21.8	22.3	22	22.9	23.6
44		17	17.6		18.7	19.5	20	20	20.8	21.4
46		14.9	15.5		16.7	17.4	17.8	18.1	18.9	19.4
48		13.1	13.5		14.8	15.4	15.8	16.4	17	17.5
50		10.8			13.1	13.7		14.6	15.3	15.7
52		6.3			11.5	12		13.1	13.6	14
54					10.1	10.5		11.6	12.1	12.4
56					8.7	9.1		10.2	10.7	11
58					7.5	7.8		9	9.4	
60					5.3			7.8	8.2	
62								6.7	7.1	
64								5.6	6	
66								4.9	5.1	
68								3.9	3.7	
70										
72										
74										
76										
78										
ブーム伸長率(%)			92			92			92	
	II		92			92			92	
	III		92			92			92	
	IV		0			46			92	
	V		0			46			46	
	VI		0			0			46	

*アダプター

TAB 231499/231501/231503/231506/231508/231510

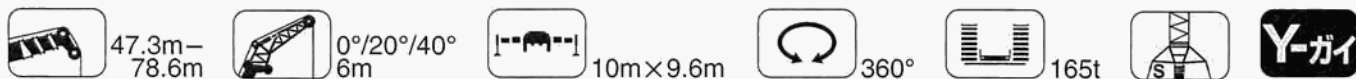

メインブーム長さ		73.4m+2.2m*			78.6m+2.2m*		
ジブ長さ		6m			6m		
角度		0°	20°	40°	0°	20°	40°
作業半径(m)							
14		59					
16		55					
18		52	50		47		
20		46	47.5	38.5	44.5	40.5	36.5
22		43	45	36.5	42	38.5	35
24		40	42.5	35	38	37	35
26		37.5	40.5	35	36	35.5	33.5
28		35	38	34	34.5	33	31.5
30		33	35.5	33.5	32.5	32	30.5
32		31	33	33	31	30.5	29.6
34		28.8	31.5	31	29	28.8	28.7
36		26.6	29.4	29.5	27.2	27.1	27.2
38		24.4	27.4	27.8	25.4	25.6	25.6
40		22.1	25.1	25.9	23.7	24.1	24.2
42		20.1	22.9	23.6	22.1	22.7	22.9
44		18.3	20.9	21.5	20.5	21.2	21.6
46		16.6	19	19.6	18.8	19.5	20.1
48		15	17.3	17.8	17.1	17.8	18.3
50		13.6	15.7	16.2	15.6	16.3	16.7
52		12.1	14.2	14.6	14.2	14.8	15.2
54		10.7	12.7	13	12.8	13.4	13.8
56		9.5	11.3	11.6	11.6	12.1	12.5
58		8.3	10	10.2	10.3	10.8	11.1
60		7.2	8.8		9.2	9.6	9.9
62		6.2	7.6		8.1	8.5	8.7
64		5.3	6.6		7.1	7.4	7.6
66		4.6	5.5		6.1	6.4	
68		3.8	4.8		5.2	5.5	
70		3	4.1		4.5	4.8	
72			3.2		3.9	4.1	
74					3.1	3.3	
76					2.3	2.5	
78						1.6	
ブーム伸長率(%)			92			92	
	II		92			92	
	III		92			92	
	IV		92			92	
	V		92			92	
	VI		46			92	

*アダプター

TAB 231499/231501/231503/231506/231508/231510

オールテレーンクレーン



16.1m-50m

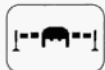

10m×9.6m



360°



135t

メインブーム 作業半径(m) 長さ	16.1m				21.3m	26.5m	31.7m	36.9m	42.1m	47.3m	50m	
	1)	2)	3)									
3	550	274	550	274								
3.5	440	274	440	274	274							
4	358	274	358	274	274	272						
4.5	301	274	301	274	274	262						
5	295	274	288	274	274	254	206					
6	261	261	256	245	244	233	188	166				
7	235	235	230	219	219	214	174	154	133			
8	213	213	208	197	197	196	162	144	124	108		
9	194	194	184	178	178	177	152	134	117	102	89	
10	177	177	165	161	161	161	143	124	110	97	84	
12	146	146	137	135	137	134	123	108	97	88	76	
14	124	124	116	116	117	115	109	96	86	79	69	
16					101	99	98	86	78	71	62	
18					88	87	87	78	70	64	57	
20					73	78	77	70	62	58	52	
22						70	69	65	58	53	47	
24						63	61	60	54	48.5	42.5	
26							55	55	51	45	39	
28							50	50	47.5	42	36	
30							46	46	44.5	39	33.5	
32								42	41	36	30.5	
34								39	38	34	28.9	
36									35.5	32.5	27.2	
38									33.5	30.5	25.6	
40									31.5	29	24.1	
42										27.4	22.7	
44										25.9	21.3	
46										19.8	20	
48											18.7	
ブーム 伸長率 (%)	I	0				46	46	46	92	92	92	100
	II	0				0	46	46	46	92	92	100
	III	0				0	0	46	46	46	92	100

1) 後方吊り、165tカウンターウエイト

2) 360°、165tカウンターウエイト

3) 後方吊り、135tカウンターウエイト

TAB 216388,216390,216391



16.1m-50m



10m×9.6m



360°



105t

メインブーム 作業半径(m) 長さ	16.1m	21.3m	26.5m	31.7m	36.9m	42.1m	47.3m	50m	
	3	274							
3.5	274	274							
4	274	274	247						
4.5	263	261	238						
5	245	244	231	187					
6	217	215	212	171	151				
7	192	192	192	158	140	121			
8	171	171	170	147	131	113	98		
9	154	153	153	138	121	106	93	81	
10	139	139	138	130	113	100	88	76	
12	115	116	114	111	98	88	80	69	
14	97	98	96	97	87	79	72	62	
16		84	84	83	78	71	64	56	
18		73	73	72	70	63	58	52	
20		64	64	63	62	57	53	47	
22			56	55	55	53	48.5	42.5	
24			50	50	49.5	48.5	44	38.5	
26				46	44	43.5	41	35.5	
28				41.5	40	40.5	38	33	
30				38	36	37	35.5	30.5	
32					32.5	33.5	32.5	27.9	
34					30	30.5	29.5	26.3	
36						28.1	27	24.7	
38						25.9	24.8	23.3	
40						24	22.8	21.9	
42							21	20.6	
44							19.4	19.4	
46							18	17.9	
48								16.7	
ブーム 伸長率 (%)	I	0	46	46	46	92	92	92	100
	II	0	0	46	46	92	92	92	100
	III	0	0	0	46	0	46	92	100

TAB 216362



31.7m-50m



10m×9.6m



360°



165t



メインブーム 長さ 作業半径(m)	31.7m		36.9m			42.1m	47.3m	50m	
	8			182					
9	178	158	168	169		158	148	132	
10	164	154	155	156	146	147	139	132	
12	141	142	135	135	135	128	123	119	
14	122	123	118	118	120	116	110	107	
16	106	106	104	105	107	103	100	97	
18	93	93	91	92	95	92	91	89	
20	82	83	81	81	84	82	82	82	
22	73	74	71	72	75	73	74	74	
24	65	66	64	65	67	65	66	67	
26	59	59	57	58	61	59	60	60	
28	51	52	52	52	55	53	54	55	
30	41.5	42	46.5	47.5	50	48	49.5	50	
32			42.5	43	46	44	45	45.5	
34			35.5	37	39.5	40	41.5	41.5	
36						36.5	38	38	
38						33.5	35	35	
40						27	32.5	32.5	
42							29.8	30	
44							26.5	27.8	
46							16.5	25.8	
48								19.5	
ブーム 伸長率 (%)	I	46	0	92	92	0	92	92	100
	II	46	92	92	46	92	92	92	100
	III	46	46	0	46	92	46	92	100

TAB 216262



31.7m-50m



10m×9.6m



360°



135t



メインブーム 長さ 作業半径(m)	31.7m		36.9m			42.1m	47.3m	50m	
	5	209	176						
6	202	170	212	194	164				
7	197	166	198	188	158	183			
8	192	162	182	180	154	170	156	132	
9	178	158	168	169	149	158	148	132	
10	163	154	155	156	146	147	139	132	
12	136	136	134	135	135	128	123	119	
14	115	116	114	115	117	114	110	107	
16	99	100	98	99	101	99	98	97	
18	86	87	85	85	88	86	87	86	
20	76	76	74	75	78	76	77	77	
22	67	67	65	66	69	67	68	68	
24	59	60	58	59	62	59	61	61	
26	53	54	52	52	55	53	54	55	
28	47.5	48.5	46.5	47	50	47.5	49	49.5	
30	41.5	42	41.5	42.5	45.5	43	44.5	44.5	
32			37.5	38	41	39	40.5	40.5	
34			34	34.5	37.5	35.5	36.5	37	
36						32	33.5	33.5	
38						29.4	30.5	31	
40						26.9	28.1	28.3	
42							25.9	26.1	
44							23.8	24	
46							16.5	22.1	
48								19.5	
ブーム 伸長率 (%)	I	46	0	92	92	0	92	92	100
	II	46	92	92	46	92	92	92	100
	III	46	46	0	46	92	46	92	100

TAB 216263

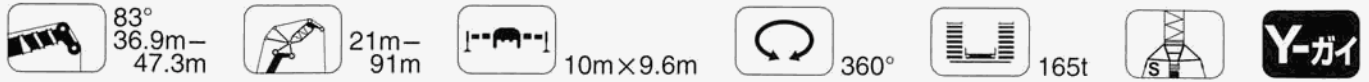

メインブーム長さ		36.9m+4m*										42.1m+4m*						
ジブ長さ		21m	28m	35m	42m	49m	56m	63m	70m	77m	84m	91m	21m	28m	35m	42m	49m	56m
16		104											97					
18		94	92										89	86				
20		86	85										82	80	76			
22		79	78	82									77	74	72			
24		73	72	71	71								71	69	67	66		
26		67	67	66	64	59							66	65	63	60	54	
28			62	61	60	57	46							61	59	57	53	43
30			57	56	56	55	44	38.5						56	56	54	51	42.5
32			53	53	52	51	43	37.5	29.3					52	52	51	49	41.5
34				49	48.5	48	41.5	37	27.3	26				49	48.5	48	46.5	41
36				46	45.5	45	40.5	36.5	26.3	24.5					45.5	45	44.5	40
38				43.5	43	42	39.5	36	25.5	23.8					42.5	42	41.5	39
40				41	40.5	39.5	38	35.5	24.6	23.1	16				40.5	40	39	38
42					38	37.5	37	35	23.9	22.5	17.1					37.5	37	36.5
44					36	35.5	35	34	23.1	21.9	16.5					35.5	35	34.5
46					34.5	33.5	33	33	22.4	21.3	16					34	33	32.5
48						31.5	31	31	21.7	20.8	15.5					31.5	31.5	31
50						30.5	30	29.6	21.1	20.2	15						30	29.3
52						28.5	28	28	20.6	19.7	14.6						28.6	27.9
54						27.2	26.9	26.9	20.1	19.2	14.1						27.2	26.6
56						24.5	26	25.6	19.7	18.8	13.7							25.3
58							24.8	24.5	19.2	18.4	13.3							24.2
60							21.4	23.4	18.8	18.1	13							23.2
62								22.4	18.4	17.7	12.7							22.1
64								21.5	18	17.4	12.4							21.1
66								19.1	17.6	17	12.1							20.9
68									15.8	16.7	11.9							20.7
70										16.4	11.6							20.5
72										16.1	11.3							20.3
74										15.8	11.1							20.1
76										15.6	10.8							
78										14.8	10.6							
80										12.6	10.4							
82										10.4	10.3							
84											10.1							
86											10							
88											9.4							
90																		
92																		
94																		
96																		
98																		
ブーム伸長率 (%)							92								92			
							92								92			
							0								46			

*アダプター TAB 221510

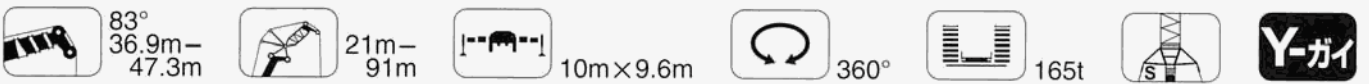

メインブーム長さ		42.1m+4m*						47.3m+4m*									
ジブ長さ		63m	70m	77m	84m	91m	21m	28m	35m	42m	49m	56m	63m	70m	77m	84m	91m
18							83										
20							76	74									
22							71	69	66								
24							67	64	62	58							
26							65	60	58	55	50						
28							60	57	55	53	48.5	41					
30	36							55	52	50	47	40.5	34				
32	35.5	27.8						52	49	47.5	45	40	34				
34	35	26.9	24.5					48.5	47.5	45.5	43.5	39.5	33.5	26.4			
36	35	26.9			18.6				44.5	43	42	38.5	33	25.6			
38	34.5	26.2	23.4		18	15.7			42	41.5	40	37.5	32.5	24.9	22.4		
40	34	24.4	22.8		17.4	15.2			42	41.5	40	37.5	32.5	24.9	22.4	17.7	
42	33.5	23.7	22.2		16.9	14.8			39.5	39	38.5	36.5	32.5	24.4	22.4	17.2	13.8
44	33	23	21.7	16.4	14.3				37.5	37	36	35	32	23.5	21.8	16.6	13.9
46	32	22.3	21.1	15.9	13.9				35	34	34	32	31.5	23.5	21.8	16.2	13.7
48	30.5	21.7	20.6	15.4	13.5				33	32.5	32	30.5	29.7	22.6	20.9	15.7	13.4
50	29	21	20.1	14.9	13.2				31.5	31	30.5	29.7	29.1	21.6	20.4	15.2	13.1
52	27.6	20.5	19.6	14.5	12.8					29.3	28.8	28.3	27.5	21.6	20.5	14.8	12.8
54	26.2	20	19.1	14.1	12.5					27.9	27.5	26.9	26.1	20.5	19.4	14.4	12.5
56	25	19.6	18.7	13.7	12.2					26.6	26.1	25.6	24.9	20	19	14	12.2
58	23.9	19.2	18.3	13.3	11.9					25.2	24.9	24.4	23.8	19.6	18.6	13.6	12
60	22.8	18.7	18	13	11.6						23.8	23.3	22.8	19.2	18.2	13.2	11.7
62	21.8	18.4	17.6	12.7	11.3						22.8	22.2	21.8	18.8	17.8	12.9	11.4
64	20.9	18	17.3	12.4	11						21.8	21.3	20.9	18.4	17.5	12.6	11.1
66	20.1	17.6	17	12.1	10.8							20.3	18	17.2	12.3	10.9	
68	18.6	17.2	16.7	11.9	10.6							19.5	17.7	16.9	12.1	10.7	
70		16.8	16.4	11.6	10.4							18.7	17.3	16.6	11.8	10.5	
72		16.6	16.1	11.4	10.2							17	16.8	16.3	11.6	10.3	
74		16.2	15.8	11.1	10							16.7	16.7	16.1	11.3	10.1	
76		13	15.4	10.9	9.9							16.2	16.2	15.5	11.1	9.9	
78			14.8	10.7	9.7							14.9	14.9	14.9	10.9	9.8	
80			14.2	10.4	9.5									14.3	10.7	9.6	
82			12.5	10.2	9.3									13.7	10.5	9.5	
84				10.1	9.2									13.2	10.2	9.3	
86				9.9	9									11.5	10	9.1	
88				9.9	8.8										9.9	8.8	
90				8.8	8.7										9.8	8.7	
92					8.7											8.6	
94					8.6											8.5	
96					7.6											8.3	
98																7	
ブーム伸長率 (%)																	

*アダプター TAB 221510

オールテレーンクレーン

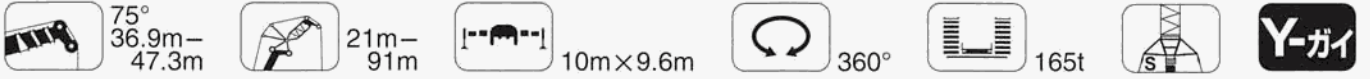

メインブーム長さ ジブ長さ	36.9m+4m*										42.1m+4m*						
	21m	28m	35m	42m	49m	56m	63m	70m	77m	84m	91m	21m	28m	35m	42m	49m	56m
24	66											59					
26	61	60										55	54				
28	56	56										51	50				
30	52	52	51									47.5	46.5	46			
32	49	48	47										43.5	43			
34		45	44	43.5									41	40			
36		42	41	40.5	40									37	39.5		
38		39.5	38.5	38	37.5									37.5	37	36.5	
40			36.5	36	35	34.5								36.5	35	34	
42			34.5	34	33	32.5	32							36.5	33	32.5	31.5
44			32.5	32	31.5	31	30.5								31.5	30.5	29.7
46			31	30.5	29.7	29.1	28.7	24.3							30	29.5	28.9
48				28.8	28.1	27.6	27.2	23.6								28	27.3
50				27.4	26.7	26.2	25.8	22.9	21.6							26.6	26
52				26.1	25.4	24.9	24.5	22.2	21	15.7						25.3	24.7
54					24.2	23.7	23.3	21.6	20.5	15.3						24.1	23.5
56					23.1	22.6	22.2	21	20	14.8	13						22.4
58					22	21.5	21.1	20.5	19.5	14.4	12.6						21.4
60					21.1	20.5	20.2	19.5	19.1	14	12.3						20.4
62						19.6	19.3	18.6	18.2	13.6	12						18.8
64						18.8	18.4	17.8	17.3	13.2	11.7						18
66						18	17.6	17	16.5	12.9	11.4						17.2
68							16.9	16.2	15.8	12.6	11.1						16.5
70							16.2	15.5	15.1	12.3	10.9						
72							15.5	14.9	14.4	12.1	10.7						
74							14.9	14.3	13.8	11.8	10.5						
76							14.3	13.7	13.2	11.6	10.3						
78							13.7	13.1	12.7	11.3	10.1						
80							13.1	12.6	12.1	11	9.9						
82							12.6	12.1	11.6	10.8	9.7						
84								11.1	10.5	9.6	8.6						
86								10.7	10.1	9.4	8.4						
88								10.2	9.7	9.1	8.3						
90									9.3	8.7	8.1						
92									8.9	8.3	7.9						
94									8.5	8.1	7.7						
96										7.6	7.3						
98										7.3	7.1						
100										6.9	6.7						
ブーム伸長率 (%)	92										92						
	0										46						

*アダプター

TAB 221512

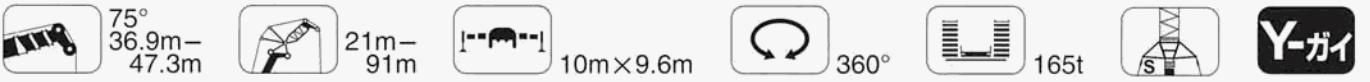

メインブーム長さ ジブ長さ	42.1m+4m*					47.3m+4m*										
	63m	70m	77m	84m	91m	21m	28m	35m	42m	49m	56m	63m	70m	77m	84m	91m
28						52										
30						49.5	48.5									
32						46	45.5									
34						43	42.5	41.5								
36							40	39	38							
38							37.5	36.5	36							
40							35.5	34.5	33.5							
42							33.5	32.5	32	33						
44	29.2						31	30	29.4	28.8						
46	27.6							29.2	28.4	27.8	26.5					
48	26.1	23.6						27.7	26.9	26.3	25.8					
50	24.8	23							25.6	24.9	24.4	23.7				
52	23.5	22.3	20.9						24.3	23.7	23.2	22.5	22.9			
54	22.3	21.7	20.4	15.3					23.2	22.5	22	21.3	21			
56	21.2	20.6	19.9	14.9					22.1	21.5	21	20.3	19.9	20		
58	20.2	19.6	19.1	14.5	12.6					20.5	20	19.3	19	18.2	14.4	
60	19.3	18.7	18.2	14.1	12.3					19.6	19.1	18.4	18.1	17.3	14	12.2
62	18.4	17.8	17.3	13.7	12					18.7	18.2	17.6	17.2	16.5	13.7	11.9
64	17.6	17	16.5	13.3	11.7						18.2	17.6	16.8	16.4	13.3	11.6
66	16.8	16.2	15.7	12.9	11.4						17.4	16	15.6	14.9	13	11.4
68	16.1	15.5	15	12.7	11.2						16.6	15.3	14.9	14.2	12.6	11.1
70	15.4	14.8	14.3	12.4	10.9						15.9	14.7	14.3	13.6	12.4	10.9
72	14.8	14.2	13.7	12.1	10.7						15.3	14	13.7	12.9	12.1	10.7
74	14.2	13.5	13.1	11.9	10.5							13.4	13.1	12.4	11.8	10.5
76		13	12.5	11.6	10.3							12.9	12.5	11.8	11.2	10.1
78		12.4	12	11.4	10.1								12	11.3	10.7	9.7
80		11.9	11.5	10.9	10								11.5	10.8	10.2	9.2
82		11.5	11	10.4	9.8								11	10.3	9.7	8.8
84			10.5	9.9	9.3								10.6	9.9	9.3	8.4
86			10.1	9.5	8.9									9.4	8.8	8.1
88			9.6	9.1	8.5									9	8.4	7.7
90				8.7	8.1									8.6	8.1	7.3
92				8.3	7.7										7.7	7
94				7.9	7.4										7.3	6.6
96				7.6	7										7	6.3
98					6.7										6.7	6.2
100					6.4										6	5.5
ブーム伸長率 (%)	92					92										
	46					92										

*アダプター

TAB 221512

オールテレーンクレーン

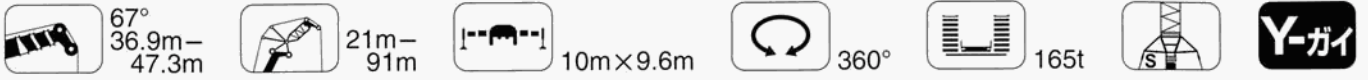

メインブーム長さ		36.9m+4m*										42.1m+4m*						
ジブ長さ		21m	28m	35m	42m	49m	56m	63m	70m	77m	84m	91m	21m	28m	35m	42m	49m	56m
作業半径(m)																		
32	44																	
34	41																	
36	38.5												39.5					
38													37					
40													35					
42														34				
44														32				
46														30				
48														28.5				
50														27				
52															29.3			
54															27.7			
56															26.2			
58															25.6			
60															24.8			
62															24.2			
64															23			
66															22.4			
68																22.3		
70																21.1		
72																20.1		
74																19.1		
76																18.2		
78																17.4		
80																16.5		
82																15.8		
84																15		
86																14.4		
88																13.7		
90																13.1		
92																12.5		
94																12		
96																		
98																		
100																		
104																		
108																		
ブーム伸長率(%)																		
I																		
II																		
III																		

*アダプター

TAB 221514

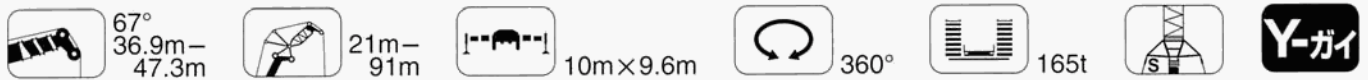

メインブーム長さ		42.1m+4m*						47.3m+4m*									
ジブ長さ		63m	70m	77m	84m	91m	21m	28m	35m	42m	49m	56m	63m	70m	77m	84m	91m
作業半径(m)																	
36																	
38																	
40																	
42																	
44																	
46																	
48																	
50																	
52																	
54																	
56																	
58																	
60																	
62																	
64																	
66																	
68																	
70																	
72																	
74																	
76																	
78																	
80																	
82																	
84																	
86																	
88																	
90																	
92																	
94																	
96																	
98																	
100																	
104																	
108																	
ブーム伸長率(%)																	
I																	
II																	
III																	

*アダプター

TAB 221514

オールテレーンクレーン

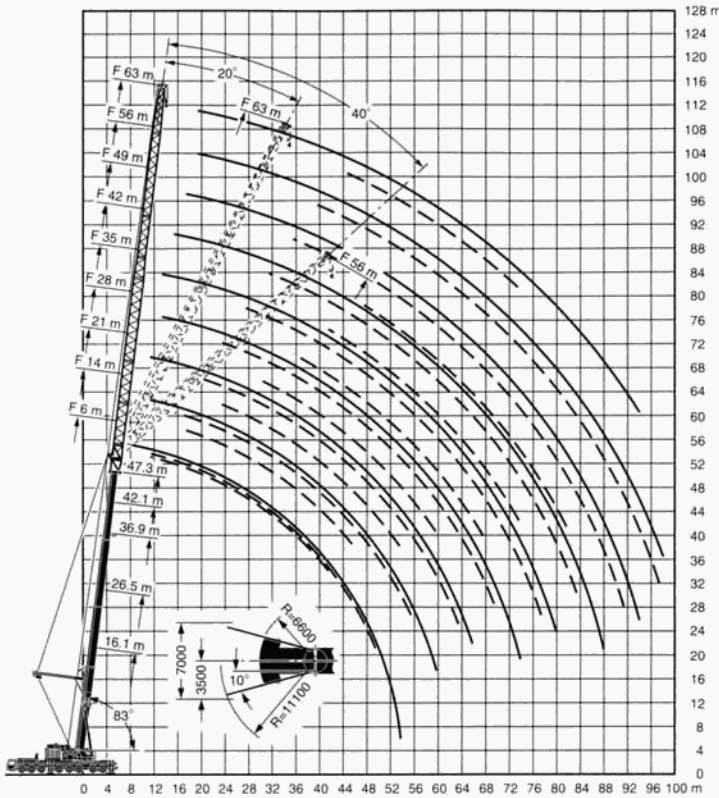

注意

- 1 定格総荷重はフックブロック、玉掛ワイヤー等の自重を含みます。
また、下記の条件が考慮されていませんのでクレーンの操作には充分気をつけてください。
① 地盤の強度、地震による影響
② 作業速度に応じた動荷重および台風または強風による影響等
- 2 本機は水平に設置して、クレーン作業を行ってください。
- 3 作業半径は、クレーンの旋回中心から荷重の重心までの水平距離です。
- 4 メインブームの定格総荷重は補助ジブを取り除いた状態での値です。
- 5 メインブーム50m仕様で274トンを超える定格総荷重の場合は、特殊吊装置が必要です。



47.3m



0°
6m-
63m



10m×9.6m



360°



165t



オールテレーンクレーン

メインブーム長さ		47.3m+2.2m*								
ジブ長さ		6m	14m	21m	28m	35m	42m	49m	56m	63m
作業半径(m)										
9	105									
10	104									
12	103									
14	97		74							
16	88		68							
18	80		64		56					
20	73		60		53					
22	67		56		49.5					
24	62		53		46.5					
26	57		50		44					
28	53		47.5		41.5					
30	48		45		39.5					
32	43.5		43		37.5					
34	39.5		41		36					
36	36.5		39		34					
38	33		37.5		32.5					
40	30.5		36		31					
42	28		34		29.8					
44	25.8		33		28.5					
46	23.8		31		27.3					
48	21.9		29.2		26.1					
50	20.2		26.9		25					
52	16.9		24.9		24.3					
54	9.5		23		23.2					
56			21.3		22					
58			19.7		20.5					
60			18.3		19					
62			16.9		17.6					
64			15.7		16.4					
66			12.4		15.2					
68					14.1					
70					13.8					
72					13.3					
74					12.6					
76					11.7					
78					10.9					
80					10.9					
82					10.9					
84					10.9					
86					10.9					
88					10.9					
90					10.9					
92					10.9					
94					10.9					
96					10.9					
98					10.9					
ブーム伸長率(%)						92				
						92				
						92				

*アダプター



メインブーム長さ		47.3m+2.2m*								
ジブ長さ		6m	14m	21m	28m	35m	42m	49m	56m	63m
作業半径(m)										
12	72									
14	67									
16	63									
18	59									
20	55									
22	52									
24	49									
26	46.5									
28	44.5									
30	42.5									
32	40.5									
34	38.5									
36	37									
38	34									
40	31									
42	28.5									
44	26.2									
46	24.1									
48	22.2									
50	20.4									
52										
54										
56										
58										
60										
62										
64										
66										
68										
70										
72										
74										
76										
78										
80										
82										
84										
86										
88										
90										
92										
94										
96										
98										
ブーム伸長率 (%)						92				

*アダプター

TAB 216566



メインブーム長さ		47.3m+2.2m*						
ジブ長さ		6m	14m	21m	28m	35m	42m	49m
作業半径(m)								
12	43							
14	41.5							
16	39.5							
18	38.5							
20	37							
22	36							
24	34.5							
26	34							
28	33							
30	32							
32	31.5							
34	30.5							
36	30							
38	29.8							
40	29.4							
42	28.8							
44								
46								
48								
50								
52								
54								
56								
58								
60								
62								
64								
66								
68								
70								
72								
74								
76								
78								
80								
82								
ブーム伸長率 (%)						92		

*アダプター





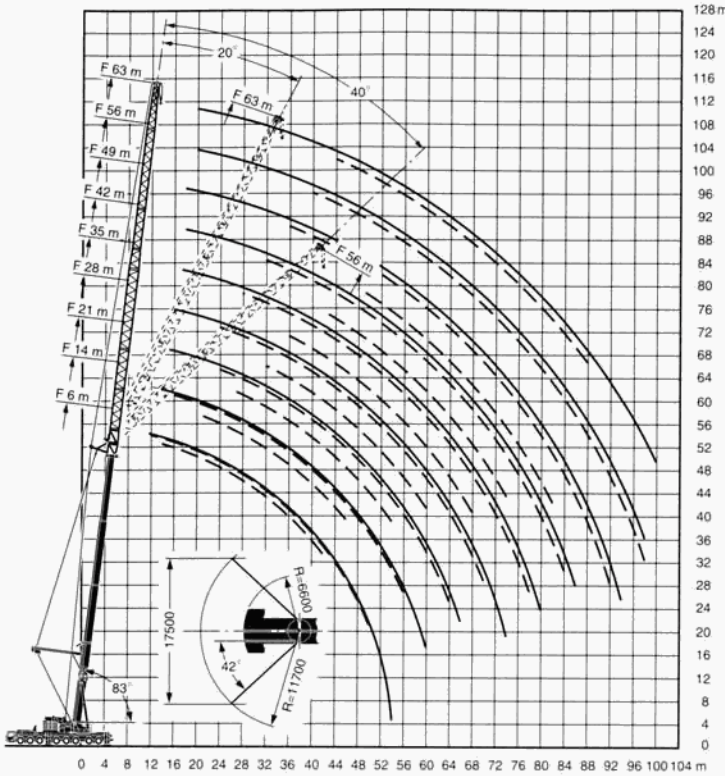

TAB 216568

オールテレーンクレーン



注意

- 1 定格総荷重はフックブロック、玉掛ワイヤー等の自重を含みます。
また、下記の条件が考慮されていませんのでクレーンの操作には充分気をつけてください。
 - ① 地盤の強度、地震による影響
 - ② 作業速度に応じた動荷重および台風または強風による影響等
- 2 本機は水平に設置して、クレーン作業を行ってください。
- 3 作業半径は、クレーンの旋回中心から荷重の重心までの水平距離です。
- 4 メインブームの定格総荷重は補助ジブを取り除いた状態での値です。
- 5 メインブーム50m仕様で274トンを超える定格総荷重の場合は、特殊吊装置が必要です。

 47.3m
  0° 6m-63m
  10m×9.6m
  360°
  165t
  Y-ガイ

メインブーム長さ ジブ長さ	47.3m+2.2m*									
作業半径(m)	6m	14m	21m	28m	35m	42m	49m	56m	63m	
10	114									
12	104									
14	92									
16	83									
18	75									
20	69									
22	63									
24	58									
26	49									
28	45.5									
30	42									
32	39									
34	35.5									
36	32.5									
38	29.9									
40	27.4									
42	25.2									
44	23.1									
46	21.3									
48	18.4									
50	14.7									
52	8									
54										
56										
58										
60										
62										
64										
66										
68										
70										
72										
74										
76										
78										
80										
82										
84										
86										
88										
90										
92										
94										
96										
98										
100										
ブーム伸長率 (%)					92					
					92					
					92					

*アダプター

TAB 216294

オールテレーンクレーン

TEY3ENZF

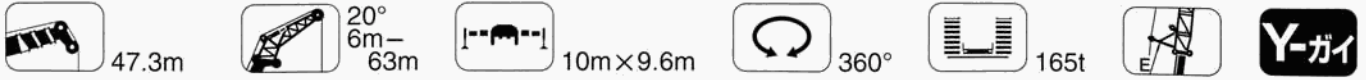

メインブーム長さ		47.3m+2.2m*								
ジブ長さ		6m	14m	21m	28m	35m	42m	49m	56m	63m
作業半径(m)										
12		72								
14		67								
16		63								
18		59	51							
20		56	49							
22		53	47	31.5						
24		51	45.5	30						
26		48.5	44	29	22.1					
28		46.5	42.5	28	21.2					
30		44.5	41.5	27	20.4	16				
32		42.5	40	26.1	19.6	15.3				
34		39.5	39	25.3	18.9	14.7	12.3			
36		36.5	38.5	24.5	18.2	14.1	11.8			
38		33	37	23.7	17.7	13.6	11.3	9		
40		30.5	34.5	23.1	17.1	13.1	10.9	8.6		
42		27.9	32.5	22.6	16.6	12.7	10.5	8.2	6.4	
44		25.6	30	22	16.1	12.2	10.1	7.9	6.1	
46		23.5	27.6	21.4	15.6	11.9	9.7	7.5	5.8	4.5
48		21.6	25.5	21	15.2	11.4	9.4	7.2	5.5	4.3
50		19.1	23.5	20.6	14.8	11.1	9.1	6.9	5.3	4.1
52			21.7	20.2	14.4	10.8	8.7	6.7	5	3.9
54			20	19.8	14.1	10.5	8.4	6.4	4.8	3.7
56			18.4	19.6	13.8	10.2	8.2	6.2	4.6	3.6
58			16.9	18.3	13.5	9.9	7.9	6	4.4	3.4
60				16.9	13.2	9.7	7.7	5.7	4.3	3.2
62				15.6	13	9.5	7.4	5.5	4.1	3.1
64				14.4	12.8	9.2	7.2	5.3	4	2.9
66				13.2	12.6	9	7	5.2	3.8	2.8
68					12.5	8.9	6.8	5	3.7	2.7
70					12.2	8.7	6.6	4.8	3.5	2.5
72					11.2	8.6	6.5	4.7	3.4	2.4
74						8.4	6.3	4.6	3.3	2.3
76						8.4	6.2	4.4	3.2	2.2
78						8.3	6.1	4.3	3.1	2.1
80						8.3	5.9	4.2	3	2
82							5.9	4.2	2.9	1.9
84							5.8	4.1	2.8	1.8
86							5.7	4	2.7	1.7
88								3.9	2.6	1.6
90								3.9	2.6	1.5
92								3.9	2.4	1.4
94								3.9	2.4	1.3
96								3.9	2.4	1.3
98								3.9	2.4	1.3
ブーム伸長率(%)						92				
						92				
						92				

*アダプター

TAB 216296

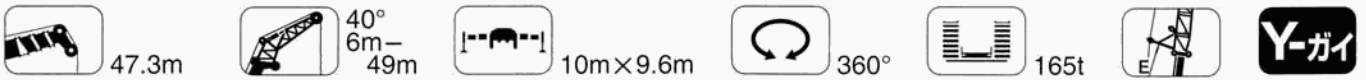

メインブーム長さ		47.3m+2.2m*						
ジブ長さ		6m	14m	21m	28m	35m	42m	49m
作業半径(m)								
14		46.5						
16		45						
18		44						
20		42.5	37					
22		41.5	36.5					
24		40.5	36					
26		39.5	35	22				
28		38.5	34	21.5				
30		38	33.5	21				
32		37.5	33	20.7	14.4			
34		37	32.5	20.3	14.1			
36		36.5	32	20	13.8	10.6		
38		33.5	31.5	19.7	13.6	10.3		
40		31	31	19.4	13.3	10.1		
42		28.2	30.5	19.2	13.1	9.9	7.3	
44			28.4	19	12.9	9.7	7.1	
46			26.2	18.9	12.7	9.5	6.9	
48				18.8	12.5	9.3	6.8	5
50				18.7	12.4	9.1	6.6	4.9
52				18.7	12.2	8.9	6.5	4.7
54				18.7	12.2	8.8	6.3	4.6
56					12.1	8.7	6.2	4.5
58					12	8.6	6.1	4.4
60					12	8.5	6	4.3
62						8.4	5.9	4.2
64						8.4	5.9	4.1
66						8.3	5.7	4.1
68						8.3	5.6	4
70						8.3	5.6	3.9
72							5.5	3.9
74							5.5	3.8
76							5.5	3.8
78								3.8
80								3.8
82								3.8
ブーム伸長率(%)						92		
						92		
						92		

*アダプター

TAB 216298

オールテレーンクレーン