

タダノ オールテレークレーン

# ATF-300G6(J)型

## 仕様書

型式呼称	ATF-300G6(J)
キャリア	FAUN ATF400G-6
スペック番号	ATF-300G-1-90101, 90102

株式会社 タダノ

## 構成図

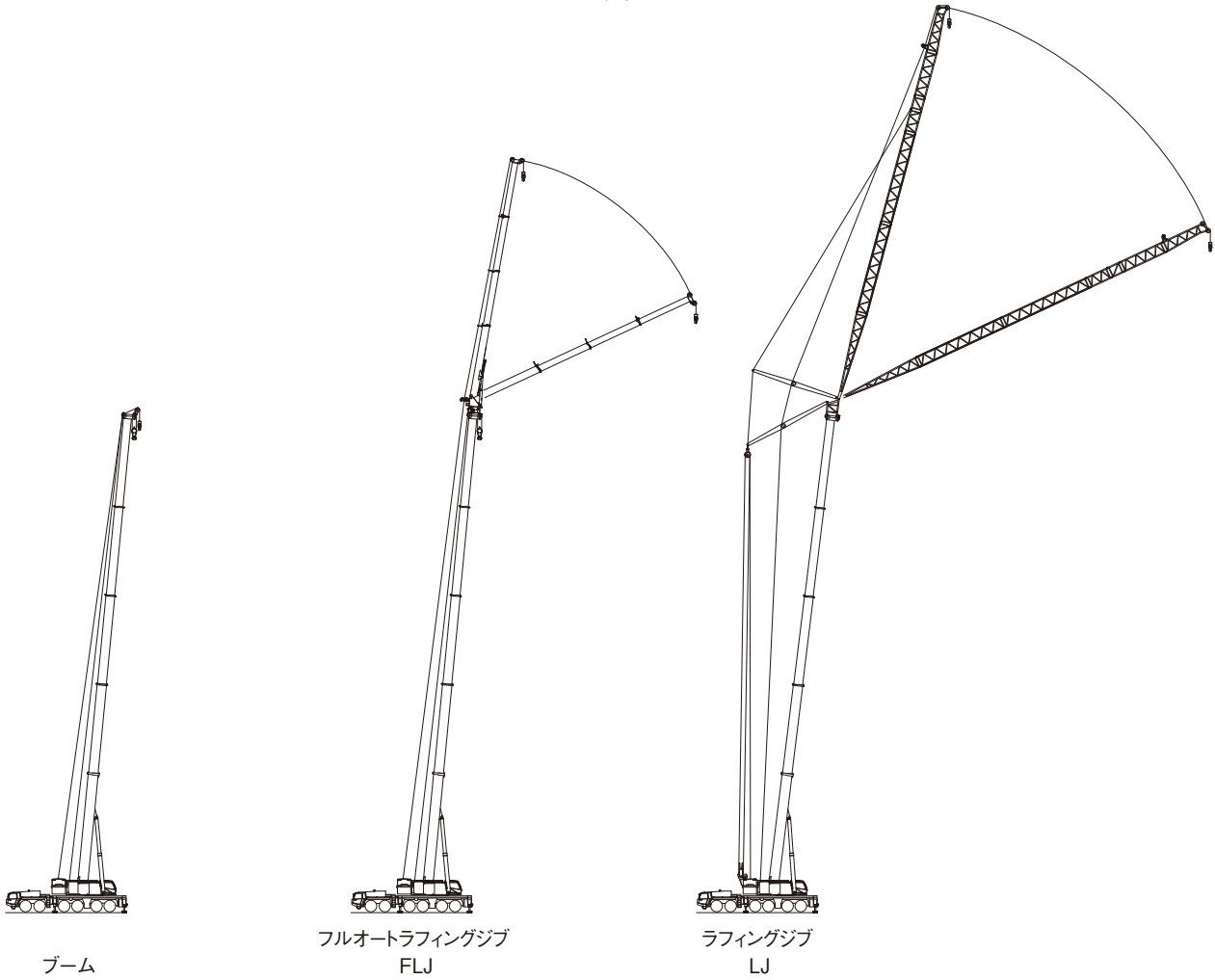

- ・ ATF-300G-1 (90101、90102 スペック) のジブは、フルオートラフィングジブ(FLJ)、ラフィングジブ(LJ)の2種類があります。
- ・ 重荷重装置は90101スペックに付き、90102スペックには付きません。それにともない、最大定格総荷重は次のようになります。

スペック	最大定格総荷重
90101	300 t
90102	200 t

カウンタウエイトとアウトリガ張出幅の組合せによって次のように定格総荷重表を選定し該当ページを読み取ってください。

ブーム									
ブーム	アウトリガ張出幅	カウンタウエイト	78 t	58 t	47 t	25 t	16.5 t	7.5 t	0 t
		8.5 m		○	○	○	○	○	○
	8.0 m		○	○	○	○	○	○	○
	6.8 m		○	○	○	○	○	○	○
	5.5 m		—	—	○	○	○	○	○
	2.7 m		—	—	—	—	—	—	○

ブーム

ブーム+フルオートラフィングジブ(FLJ)						
ブーム	アウトリガ張出幅	カウンタウエイト	78 t	58 t	47 t	25 t
		8.5 m		○	○	○
	8.0 m		○	○	○	○
	6.8 m		○	○	○	—

FLJ

ブーム+ラフィングジブ(LJ)					
ブーム	アウトリガ張出幅	カウンタウエイト	78 t	58 t	47 t
		8.5 m		○	○
	8.0 m		○	○	○
	6.8 m		○	—	—

LJ

注) —印の組合せでは、クレーン作業を行わないでください。

# 諸元

## ■クレーン

ブーム	15.0m	300.0t × 2.7m (46本掛)※ 200.0t × 4.0m (20本掛)
	20.1m	170.0t × 5.0m (17本掛)
	25.1m	162.0t × 5.0m (16本掛)
	30.2m	139.0t × 6.0m (13本掛)
	35.3m	123.4t × 5.0m (12本掛)
	40.4m	84.2t × 8.0m (8本掛)
	45.4m	71.6t × 8.0m (7本掛)
	50.5m	54.3t × 10.0m (5本掛)
	55.6m	45.0t × 11.0m (4本掛)
60.0m	34.5t × 14.0m (3本掛)	
シングルトップ	12.2t (1本掛)	
フルオート ラフィングジブ (FLJ)	2.3m+10.3m FLJ	38.4t × 9.0m (4本掛)
	2.3m+17.2m FLJ	16.7t × 24.0m (2本掛)
	2.3m+24.1m FLJ	16.0t × 14.0m (2本掛)
	2.3m+31.0m FLJ	10.9t × 16.0m (1本掛)
ラフィングジブ (LJ)	2.5m+20.3m LJ	69.7t × 14.0m (6本掛)
	2.5m+32.3m LJ	58.6t × 14.0m (5本掛)
	2.5m+34.0m LJ	40.8t × 18.0m (4本掛)
	2.5m+40.0m LJ	36.7t × 14.0m (4本掛)
	2.5m+46.0m LJ	36.7t × 16.0m (4本掛)
最大地上揚程	ブーム	60m (34.5t)
	FLJ	93m (5.7t)
	LJ	108m (6.1t)
最大作業半径	ブーム	58m (5.7t)
	FLJ	58m (2.7t)
	LJ	62m (3.4t)

※重荷重装置付きスペック

上部エンジン	形式	ベンツ OM926LA、 水冷4サイクル直列6気筒直接噴射式、 インタークーラー付ターボディーゼルエンジン、 尿素SCRシステム付
	総排気量	6.37L
	最高出力	195kW [265PS] / 2,200min <sup>-1</sup>
	最大トルク	1,100N・m {112kgf・m} / 1,200~1,600min <sup>-1</sup>
燃料タンク容量	230L	
AdBlueタンク容量	8L	
油圧ポンプ	高圧可変ピントンポンプ2個、 高圧ピストンポンプ1個、 高圧ギヤポンプ1個	
安全装置	過負荷防止装置(AML) 作業範囲制限機能、旋回範囲制限機能、 旋回自動停止機能、ブーム起伏緩停止機能、 フック移動量表示機能 カウンタウエイト組合せ検出装置、 個別検出式アウトリガ張出幅自動検出装置、 巻過防止装置、捨巻確保装置、水準器、 玉掛けロープはずれ止め、旋回ロック装置、 油圧安全弁、 油圧ロック装置(伸縮・起伏・巻上・ジャッキ)、 ウインチドラム回転計	
付属装置	カウンタウエイト着脱装置、 ブーム・起伏装置着脱装置、 速度調整装置(起伏・旋回・ウインチ・FLJ・LJ)、 風速計(ブーム・FLJ・LJ)、 リフトアジャスタ・リリースアジャスタ(ブーム)、 オイルクーラー、集中給脂装置、AML外部表示灯、 旋回警報装置、拡声器、ドラム視認モニタ、 内部チルト式クレーン運転室、 ヒータ付きシート、ヒータ・エアコン、ラジオ、 衛星通信装置(HELLO-NET Owner's Site)	
オプション	敷鉄板	

## ■キャリヤ

最高速度	85km/h	
登坂能力	tan θ = 0.46	
最小回転半径	11.6m	
全長	15,620mm	
全幅	3,000mm	
全高	3,990mm	
軸距	1,800mm+3,150mm+1,700mm+2,440mm+1,700mm	
輪距	2,540mm	
車両総重量	全重量	45,400kg
	前軸	12,110kg (1軸 + 2軸)
乗員定員	後軸	33,290kg (3軸 + 4軸 + 5軸 + 6軸)
	定員	2名
エンジン	形式	ベンツ OM502LA、 水冷4サイクルV型8気筒直接噴射式、 インタークーラー付ターボディーゼルエンジン、 尿素SCRシステム付
	総排気量	15.928L
	最高出力	480kW [653PS] / 1,800min <sup>-1</sup>
	最大トルク	3,000N・m {306kgf・m} / 1,300min <sup>-1</sup>
燃料タンク容量	450L	
AdBlueタンク容量	40L	
変速機	形式	ZF TC トロニック 自動変速式、 トルクコンバータ・インターダブレーキ付
	段	前進12段、後進2段
駆動方式	12×6 (8) 1軸 + 3軸 + (4軸) + 5軸、デフロック装置付	
車軸形式	6軸全浮動式	
懸架方式	全軸ハイドロニューマチック、レベリング調整付、 サスペンションストローク: +175mm、-90mm	
ステアリング	左ハンドル、非常ステアリングポンプ付2系統式、 パワーステアリング、特殊ステアリングモード付	
ブレーキ	主ブレーキ	空気式全輪ディスクブレーキ、2系統式
	駐車ブレーキ	3・4・5・6軸制動スプリング式
	補助ブレーキ	変速機内蔵インターダ、排気ブレーキ
タイヤ	445/95 R 25 (12輪)	
バッテリー	12V -170Ah × 2 (24V)	
付属装置	集中給脂装置、バックモニタ、ヒータ・エアコン、 ラジオ、仮眠用ベッド	

ブーム・ジブ 長さ	ブーム	15.0m ~ 60.0m
	FLJ	2.3m + 10.3m ~ 31.0m
	LJ	2.5m + 20.3m、32.3m、34.0m、40.0m、46.0m、52.0m
ブーム・ジブ 形式	ブーム	箱型5段油圧伸縮式、各段ピンロック方式
	FLJ	箱型4段同時伸縮式、 オフセット5° ~ 60° 油圧無段階傾斜式
	LJ	ラチェス型、オフセット油圧無段階傾斜式
	シングルトップ	先端ブーム取付横折曲格納式
ブーム・ジブ 伸縮装置	ブーム	複動油圧シリンダ直押し1本、 圧力補償付流量調整弁付
	FLJ	複動油圧シリンダ直押し1本、 ワイヤロープ式伸縮装置2基
ブーム伸長速度		45m / 500s
フック		200tフック(10枚シープ)、80tフック(3枚シープ)、 35tフック(1枚シープ)、12.2tフック
巻上装置		油圧モータ駆動遊星歯車減速式、自動ブレーキ、 高低圧切換装置付、シングルウインチ2基、 圧力補償付流量調節弁付
ワイヤロープ	主巻	径23mm × 長さ350m、 非自転性ワイヤロープ、スーパーストップ付
	補巻	径23mm × 長さ580m、 非自転性ワイヤロープ、スーパーストップ付
巻上速度	主巻	125m/min (5層)
	補巻	135m/min (6層)
ブーム起伏装置		複動油圧シリンダ直押し1本、圧力補償付流量調整弁付
ブーム上げ速度		0° ~ 84.5° / 90s
旋回装置		油圧モータ駆動遊星歯車減速式、 ローラー式スイングベアリング、 手動スイッチ式ブレーキ、油圧操作式旋回ロック
旋回角度		360° 連続
旋回速度		1.0min <sup>-1</sup>
カウンタウエイト		78t、58t、47t、25t、16.5t、7.5t、0t
アウトリガ		全油圧式H型、スライドロック用ピン付、 スライド格納式フロート、 張出幅: 最大8.5m、 中間8.0m、6.8m、5.5m、最小2.7m

# 走行

## ■ 公道走行状態

単位(mm)

● キャリヤ + 旋回体 45.4 t

(公道走行時の注意事項)

1. ブーム・起伏装置およびカウンタウエイト装置を別送し、クレーン用台車のみで走行しなければなりません。
2. 道路運送車両の保安基準による保安基準緩和の認定が必要です。
3. 道路法による特殊車両の通行許可が必要です。基本通行条件 重量: Cが記載された適合証明書を取得していますが、実際の通行経路で申請して許可された条件にしたがって走行しなければなりません。

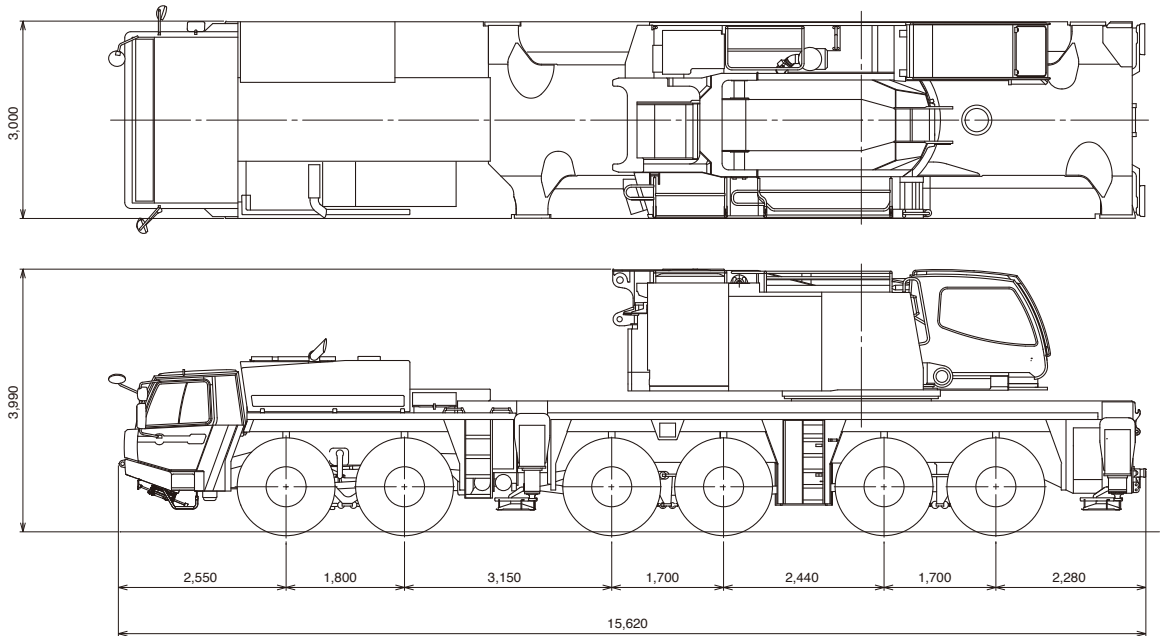

## ■ 構内移動姿勢

単位(mm)

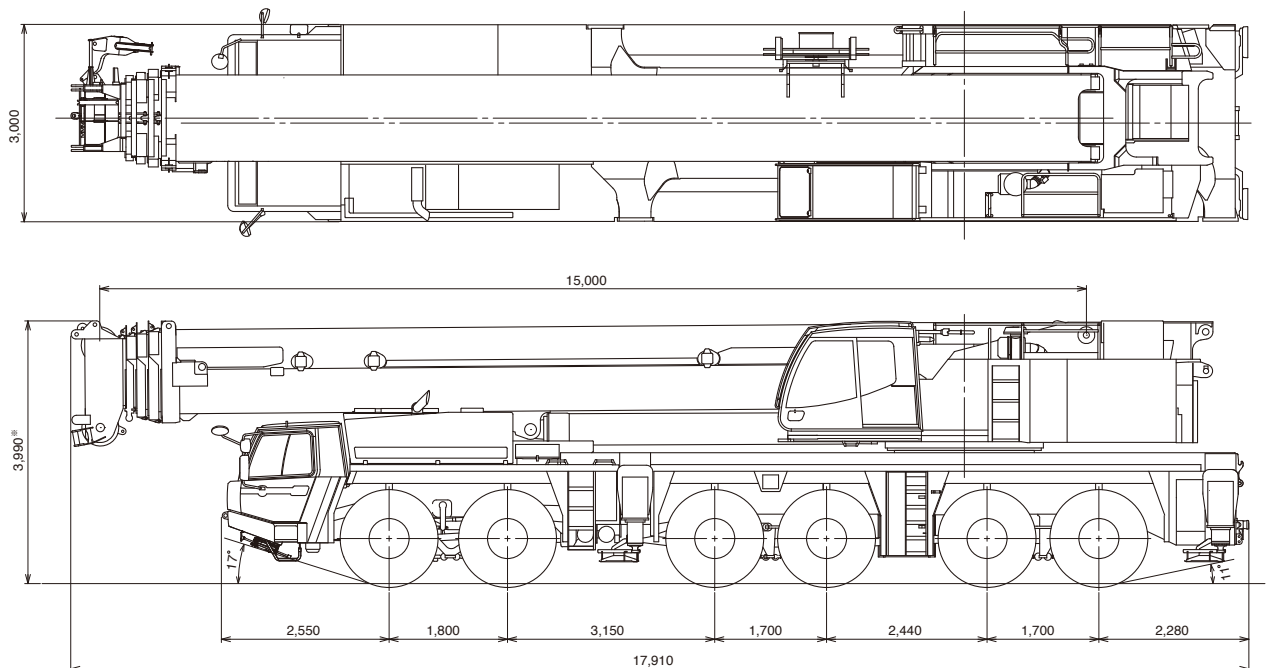

\*+175mm、-90mm (サスペンション)

最低地上高: 330mm

# 走行

## 公道走行状態

単位(mm)

### 公道走行状態

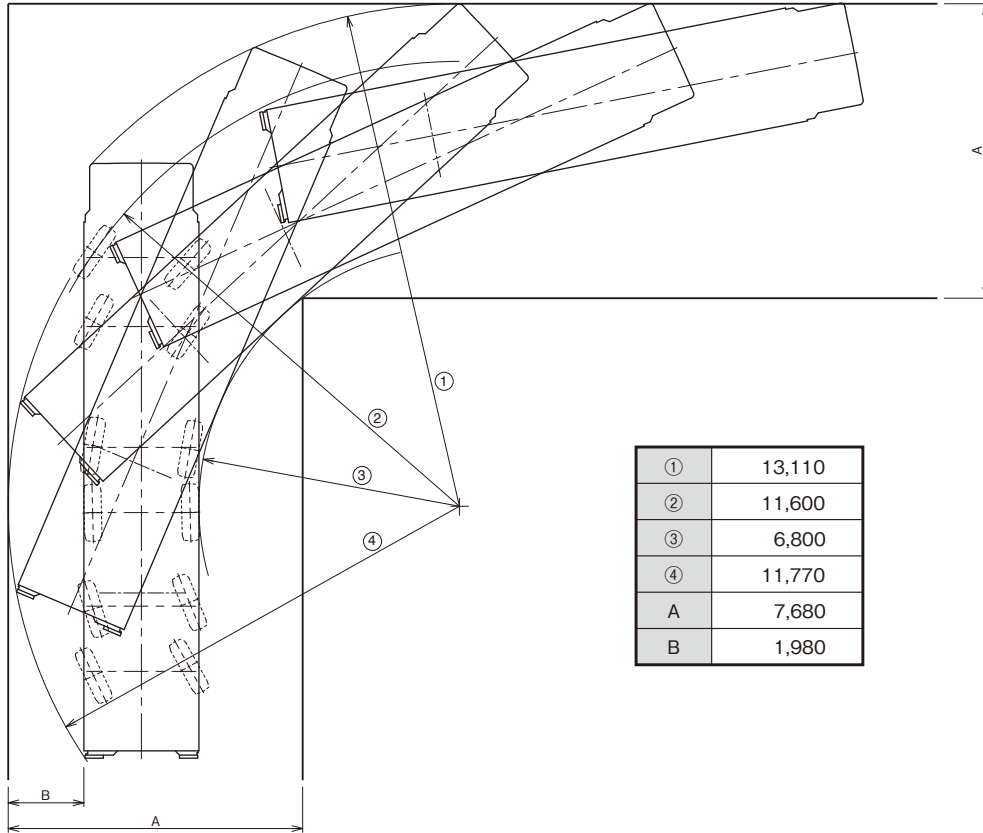

①	13,110
②	11,600
③	6,800
④	11,770
A	7,680
B	1,980

### 構内移動姿勢 (シングルトップ格納)

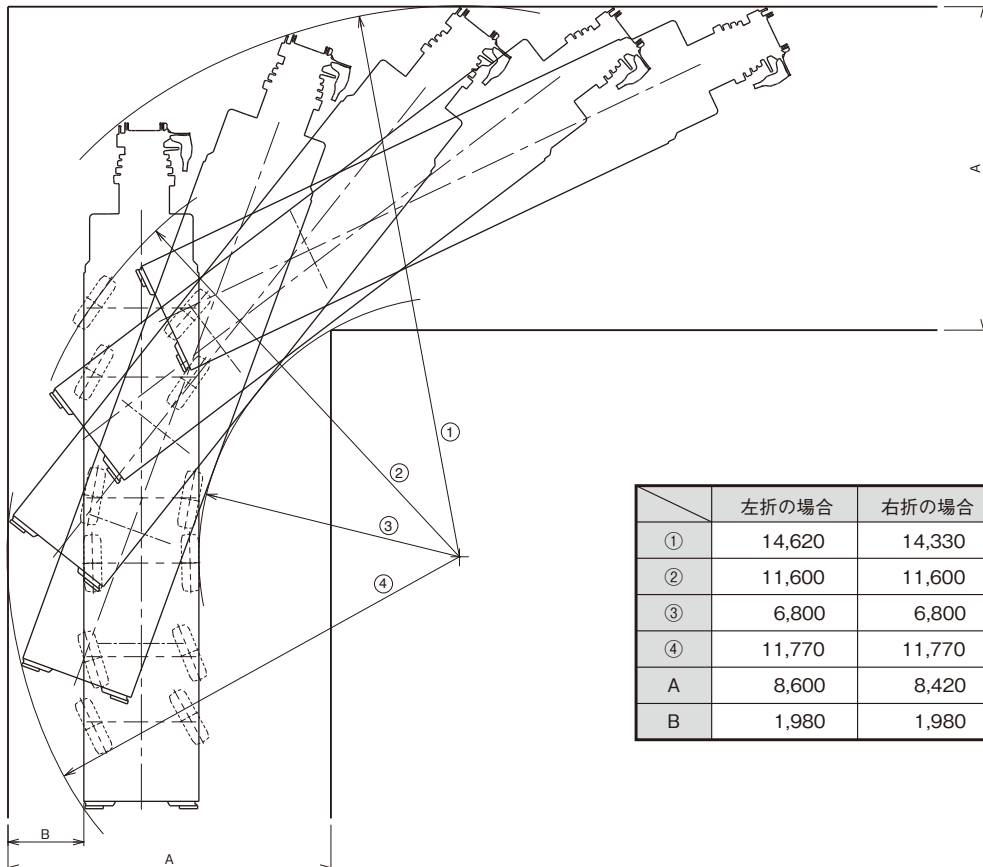

	左折の場合	右折の場合
①	14,620	14,330
②	11,600	11,600
③	6,800	6,800
④	11,770	11,770
A	8,600	8,420
B	1,980	1,980

# 搬 送

## ■ 分解搬送部品

単位(mm)

- ブーム+起伏シリンダ (ホースリール、シングルトップ付き) 28.1 t (置き台付き)  
27.5 t (置き台除く)

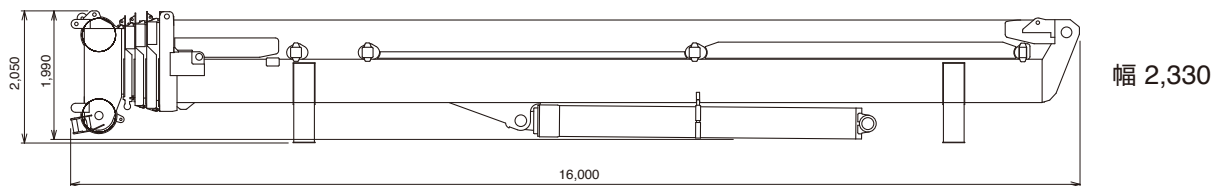

- 補巻ウインチ 4.8 t

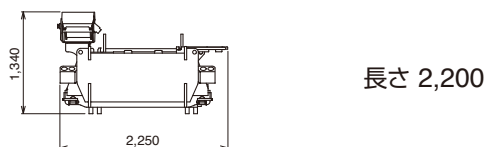

- カウンタウエイト(C/W)

- ① 7.5 t

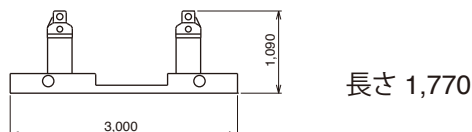

- ② 9.0 t

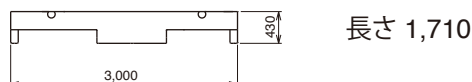

- ③ 8.5 t

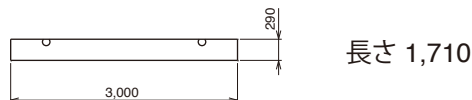

- ④ 11.0 t × 2ヶ

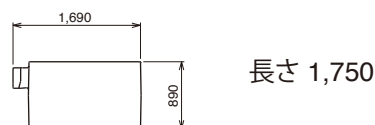

- ⑤ 11.0 t

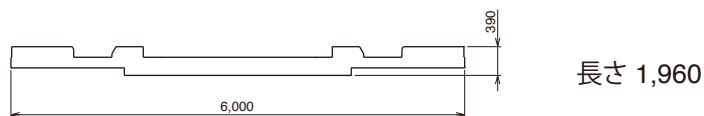

- ⑥ 10.0 t × 2ヶ

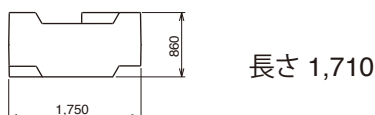

- フック

200tフック 3.2 t

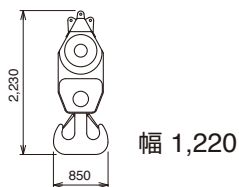

80tフック 1.55 t

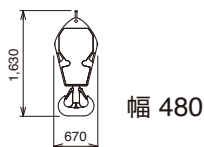

35tフック 0.95 t

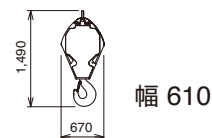

12.2tフック 0.44 t

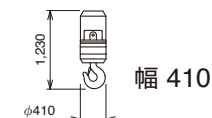

その他に付属品があります。

# 搬 送

## ■ 分解搬送部品

単位(mm)

● フルオートラフィングジブ(FLJ) 10.6 t

● アダプタ 0.8 t

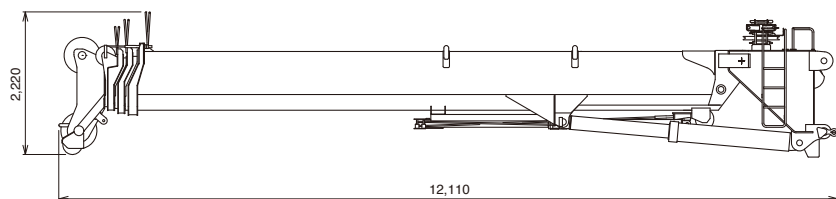

幅 1,420

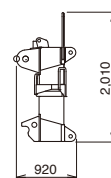

幅 2,180

● ラフィングジブ(LJ)

① ベースジブ+マスト 9.1 t

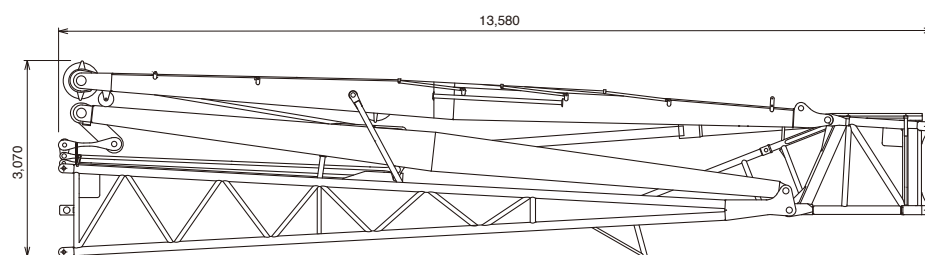

幅 2,050

② ミドルAジブ 2.8 t

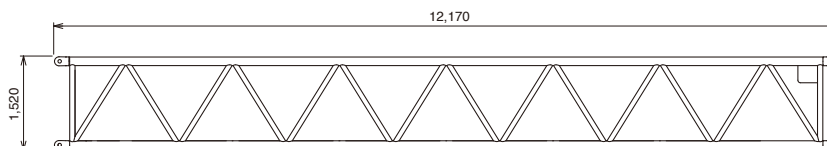

幅 1,840

③ ミドルBジブ 2.1 t

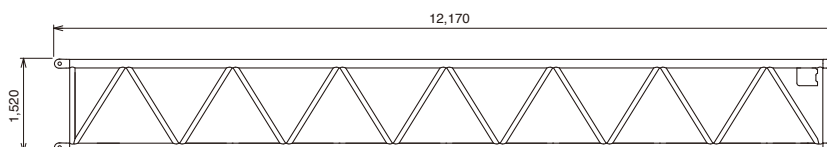

幅 1,840

④ レデューサジブ 0.75 t

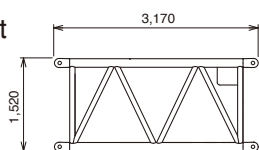

幅 1,840

⑤ ペンダントコネクタジブ 0.6 t

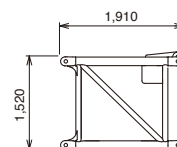

幅 1,060

⑥ ミドルCジブ 0.9 t

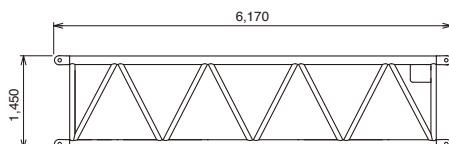

幅 1,060

⑦ トップジブ 1.45 t

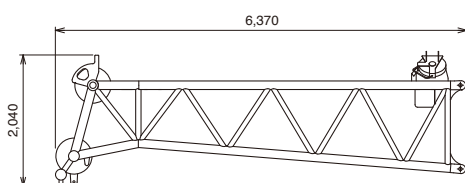

幅 1,060

● ジブトップ台車 0.4 t

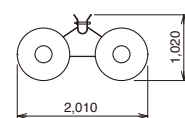

幅 1,550

その他に付属品があります。



# 搬 送

## ■ 分解搬送部品

単位(mm)

- エコライザシーブ 1.4 t (置き台付き)  
1.1 t (置き台除く)

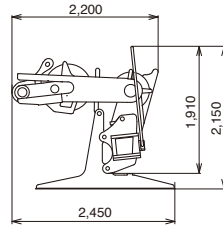

幅 1,630

- マスト3(立組用) 0.9 t

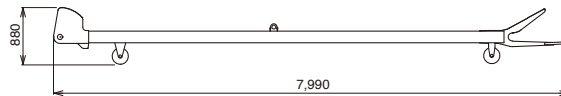

幅 1,460

- ②+⑥ ミドルAジブ + ミドルCジブ 3.7 t

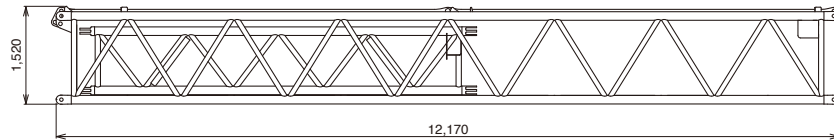

幅 1,840

- 補巻ウインチ+エコライザシーブ 5.9 t

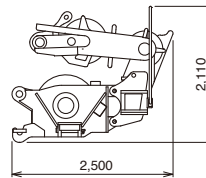

幅 2,210

- 重荷重装置 【重荷重装置付きスペックのみ】

- 重荷重ヘッド 1.5 t

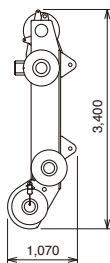

幅 1,330

- シーブサポート 0.8 t

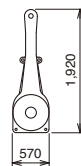

幅 1,120

- バックテンションシーブ 0.7 t

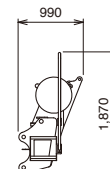

幅 1,550

- アシストジャッキ 0.3 t × 2ヶ



幅 760

- 200tフック+アタッチメントシーブ 3.3 t

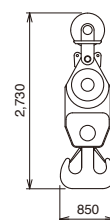

幅 1,220

その他に付属品があります。

# 設 置

## ■ アウトリガ張出幅・テールスイング

単位(mm)

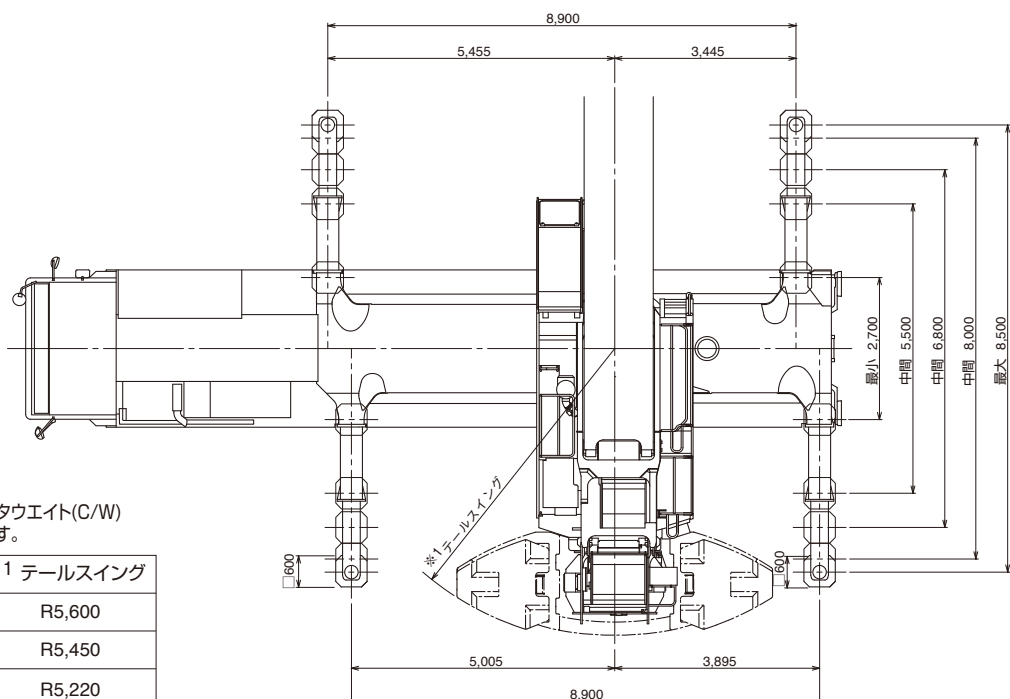
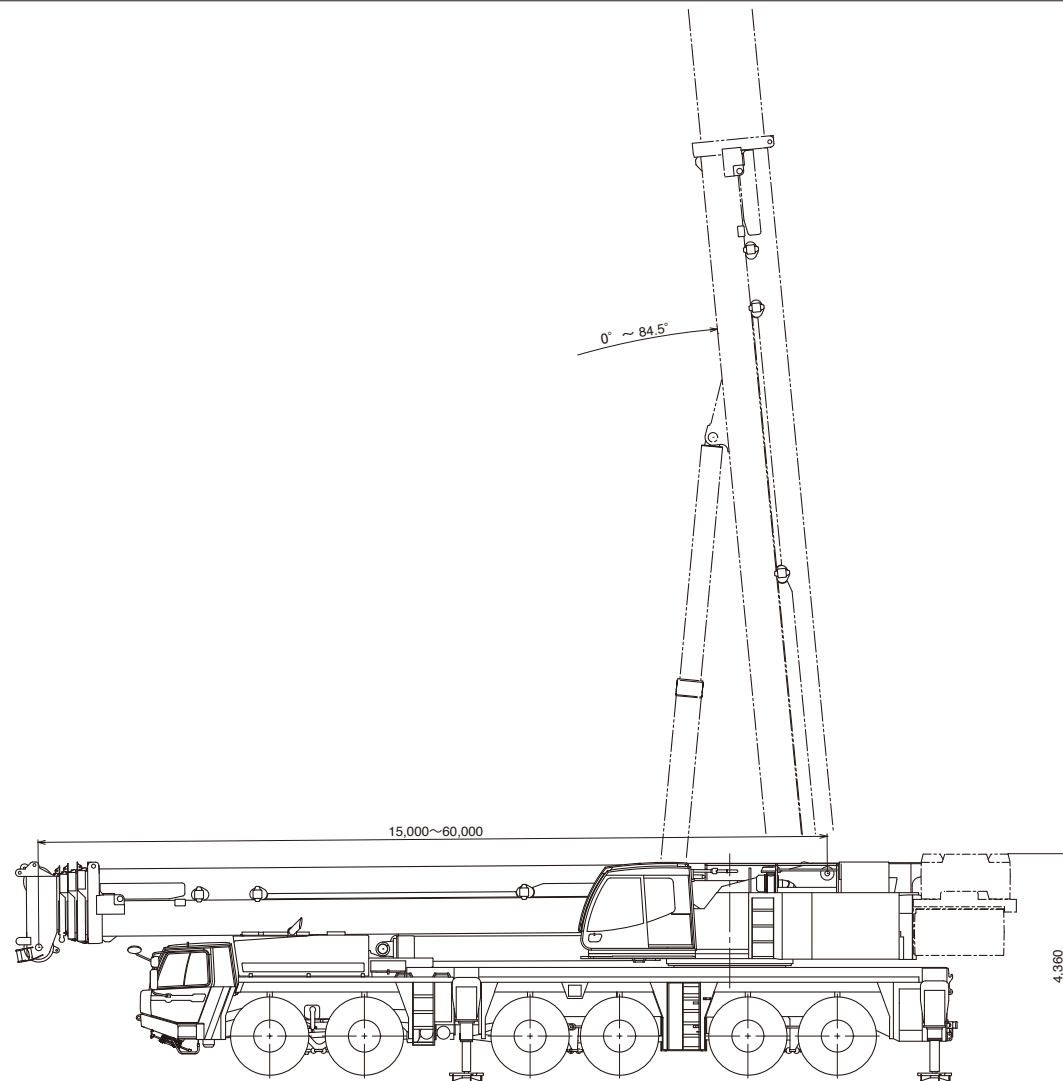

テールスイングはカウンタウエイト(C/W)  
組合せによって異なります。

カウンタウエイト	※1 テールスイング
78t ~ 138t	R5,600
47t、58t	R5,450
7.5t ~ 25t	R5,220

# 設 置

## ■ フック寸法

単位(mm)

H: ヘッドシーブ中心とハッカ上面の距離

	200tフック	80tフック	35tフック	12.2tフック
ブーム	3.2m	2.7m		
シングルトップ				2.6m
FLJ、LJ		2.7m	2.6m	2.4m

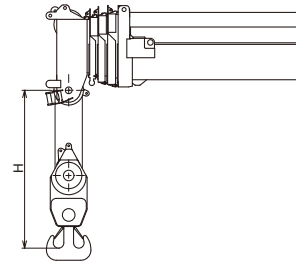

## ■ カウンタウエイト(C/W)組合せ

● 各ウエイトの使用個数を示す

合計重量	ウエイト① 7.5 t	ウエイト② 9 t	ウエイト③ 8.5 t	ウエイト④ 11 t	ウエイト⑤ 11 t	ウエイト⑥ 10 t
78 t	1	1	1	2	1	2
58 t	1	1	1	2	1	
47 t	1	1	1	2		
25 t	1	1	1			
16.5 t	1	1				
7.5 t	1					
0 t						

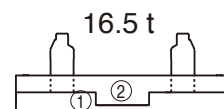
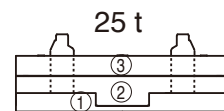
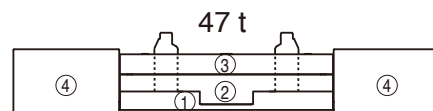
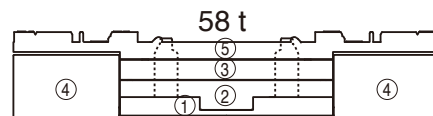
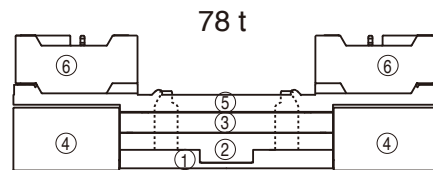

# ブーム

## ブーム作業半径－揚程図

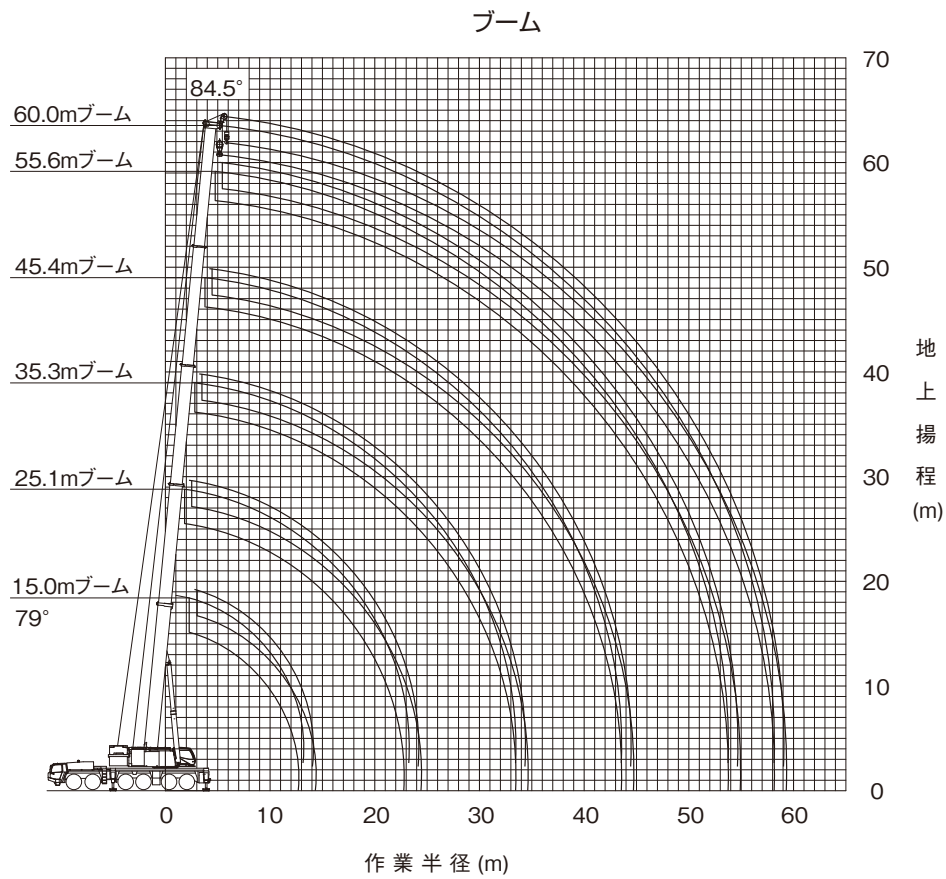

(注意)

- ◆ 上図はブームのたわみを含んでいません。
- ◆ カウンタウエイト78t、アウトリガ張出幅8.5mの性能を図示しています。

## ブーム定格総荷重表

### ■ 定格総荷重表注意事項

◆性能設定のあるカウンタウエイトとアウトリガ張出幅の組合せを、下表に○印で示します。

アウトリガ張出幅 \ カウンタウエイト	78 t	58 t	47 t	25 t	16.5 t	7.5 t	0 t
8.5 m	○	○	○	○	○	○	○
8.0 m	○	○	○	○	○	○	○
6.8 m	○	○	○	○	○	○	○
5.5 m			○	○	○	○	○
2.7 m							○

・同じブーム長さでも、ブームの伸長状態によって定格総荷重が異なります。

・カウンタウエイト0t、アウトリガ張出幅2.7mの性能は、ブーム長さ15.0～30.2mのみの設定です。

◆定格総荷重は、つり具質量とフック質量(200トンフック:3,200kg、80トンフック:1,550kg、12.2トンフック:440kg)を含んだ値を示します。

◆定格総荷重は、ブームのたわみを含んだ実際の作業半径に基づいています。

◆定格総荷重表中の標準巻掛本数より少ない本数で使用する場合、最大荷重の上限は下表のとおりです。

巻掛本数	18本	17本	16本	14本	13本	12本	11本	10本	9本	8本	7本	6本
最大荷重	186.1t	177.5t	168.6t	150.4t	141.0t	131.4t	121.6t	111.7t	101.5t	91.1t	80.5t	69.7t

巻掛本数	5本	4本	3本	1本
最大荷重	58.6t	47.4t	35.9t	12.2t

◆シングルトップ使用時の巻掛本数は1本(12.2トンフック使用)で、定格総荷重はブームの定格総荷重からブームに取り付けられているフックの質量を差し引いた値とし、かつ上限は12.2tです。

◆定格総荷重はアウトリガを水平堅土上に設置したときの値です。

◆定格総荷重表は、風による影響を含んでいません。瞬間最大風速が10m/s以上の風速では、クレーン作業を中止してください。

#### 定格総荷重表中の線、および用語説明

◆太線より上側はクレーンの強度に、下側はクレーンの安定に基づいています。

◆「ピン無最大荷重」は、Bピン(ブーム固定ピン)を挿入していないときの定格総荷重の上限を示します。

◆「 $\theta(^{\circ})$ 」は、無負荷状態で作動可能なブーム起伏角度範囲を示します。

◆「補巻時・標準巻掛本数」は、補巻使用時の標準巻掛本数を示します。

◆「主巻時・標準巻掛本数」は、主巻使用時の標準巻掛本数を示し、補巻よりもワイヤロープ長さが短い場合巻掛本数が少なくなる場合があります。

◆「主巻時・最大荷重」は、主巻使用時の定格総荷重の上限を示します。

# ブーム

カウンタウエイト 78t、アウトリガ張出幅 8.5m

## ブーム

性能ブロック	1	1	3	1	3	5	4	2	1	4	2	1	4	6	2	1	2	1	7	9	8	1	10	11	1	1	12								
性能番号	1	1	14	2	15	19	16	10	3	17	11	4	18	20	12	5	13	6	21	23	22	7	24	25	8	9	26								
ブーム長さ(m)	15.0			20.1			25.1			30.2			35.3			40.4			45.4			50.5			55.6		60.0								
作業半径(m)	2.7	3.0	3.5	4.0	4.5	5.0	6.0	7.0	8.0	9.0	10.0	11.0	12.0	14.0	16.0	18.0	20.0	22.0	24.0	26.0	28.0	30.0	32.0	34.0	36.0	38.0	40.0	44.0	48.0	50.0	52.0	54.0	56.0	58.0	
ピン無最大荷重	-	60.0	63.0	69.0	59.0	63.0	66.0	44.0	59.0	63.0	66.0	49.0	59.0	44.0	48.0	61.0			49.0		53.0		48.0	48.8	45.0	34.5									
θ(°)	0~79	0~79	0~84.5		0~84.5				0~84.5			0~84.5			0~84.5		0~84.5		0~84.5		0~84.5		0~84.5		0~84.5	3~84.5	3~84.5								
伸縮ブーム1	0	0	0	0	45	45	0	0	0	45	0	0	90	90	45	0	90	0	90	90	0	90	90	45	90	90	45	90	100	100	100	100	100	100	
伸縮ブーム2	0	0	45	0	45	0	45	0	0	45	45	0	45	45	0	45	45	0	45	45	90	90	45	90	90	45	90	90	45	90	100	100	100	100	100
伸縮ブーム3	0	0	0	0	0	45	45	0	0	45	45	45	0	45	45	0	45	45	0	45	45	90	90	45	90	90	45	90	100	100	100	100	100	100	100
伸縮ブーム4	0	0	0	45	0	0	0	45	90	0	45	90	0	45	45	90	45	90	45	90	45	90	90	45	90	90	45	90	100	100	100	100	100	100	100
標準フック	200t	200t	200t		200t			200t		200t			200t		200t		80t	200t	80t		80t		80t		80t		80t		80t		80t		80t		80t
フック重量	3200kg	3200kg			3200kg			3200kg		3200kg			3200kg		3200kg		1550kg	3200kg	1550kg		1550kg		1550kg		1550kg		1550kg		1550kg		1550kg		1550kg		1550kg
補巻時標準巻掛本数	23	20	17	13	16			13	10	13	12	8	12	11	6	6	8	6	7	6	6		5		5		4		3		3		3		3
主巻時標準巻掛本数	23	18	13					11	10	9	8	8	8	11	6	6		6	6		6		5		5		4		3		3		3		3
主巻時最大荷重	-	186.1	141.0	134.8				121.6	102.4	101.5	85.4		91.1		68.0	69.7	63.3		69.7	68.0	57.4	54.3	54.1	48.8	45.0	34.5									

※印は重荷重装置付き、後方限定の値です。

カウンタウエイト 78t、アウトリガ張出幅 8.0m

## ブーム

性能ブロック	1	3	1	3	5	4	2	1	4	2	1	4	6	2	1	2	1	7	9	8	1	10	11	1	1	12									
性能番号	1	14	2	15	19	16	10	3	17	11	4	18	20	12	5	13	6	21	23	22	7	24	25	8	9	26									
ブーム長さ(m)	15.0			20.1			25.1			30.2			35.3			40.4			45.4			50.5			55.6		60.0								
作業半径(m)	3.0	3.5	4.0	4.5	5.0	6.0	7.0	8.0	9.0	10.0	11.0	12.0	14.0	16.0	18.0	20.0	22.0	24.0	26.0	28.0	30.0	32.0	34.0	36.0	38.0	40.0	44.0	48.0	50.0	52.0	54.0	56.0	58.0		
ピン無最大荷重	60.0	63.0	69.0	59.0	63.0	66.0	44.0	59.0	63.0	66.0	49.0	59.0	44.0	48.0	61.0			49.0		53.0		48.0	48.8	45.0	34.5										
θ(°)	0~79	0~84.5		0~84.5				0~84.5			0~84.5		0~84.5		0~84.5		0~84.5		0~84.5		0~84.5		0~84.5		0~84.5	3~84.5	3~84.5								
伸縮ブーム1	0	0	0	45	45	0	0	0	45	0	0	90	90	45	0	90	0	90	90	0	90	90	45	90	90	45	90	100	100	100	100	100	100	100	
伸縮ブーム2	0	0	45	0	45	0	45	0	0	45	45	0	45	45	0	45	45	0	45	45	90	90	45	90	90	45	90	90	45	90	100	100	100	100	100
伸縮ブーム3	0	0	0	0	0	45	45	0	0	45	45	45	0	45	45	0	45	45	0	45	45	90	90	45	90	90	45	90	100	100	100	100	100	100	100
伸縮ブーム4	0	0	0	45	0	0	0	45	90	0	45	90	0	45	45	90	45	90	45	90	45	90	45	90	90	45	90	100	100	100	100	100	100	100	100
標準フック	200t	200t	200t		200t			200t		200t			200t		80t	200t	80t		80t		80t		80t		80t		80t		80t		80t		80t		80t
フック重量	3200kg	3200kg			3200kg			3200kg		3200kg			3200kg		1550kg	3200kg	1550kg		1550kg		1550kg		1550kg		1550kg		1550kg		1550kg		1550kg		1550kg		1550kg
補巻時標準巻掛本数	20	17	13	16				13	10	13	12	8	12	11	6	6	8	6	7	6	6		5		5		4		3		3		3		3
主巻時標準巻掛本数	18	13						11	10	9	8	8	11	6	6		6	6		6		5		5		4		3		3		3		3	
主巻時最大荷重	186.1	141.0	134.8					121.6	102.4	101.5	85.4		91.1		68.0	69.7	63.3		69.7	68.0	57.4	54.3	54.1	48.8	45.0	34.5									

カウンタウエイト 78t、アウトリガ張出幅 6.8m

ブーム

Table with columns for performance block, boom length, and various dimensions. Includes sub-tables for extension ratios and hook weights.

ブーム

カウンタウエイト 58t、アウトリガ張出幅 8.5m

ブーム

Table with columns for performance block, boom length, and various dimensions. Includes sub-tables for extension ratios and hook weights.





カウンタウエイト 47t、アウトリガ張出幅 8.5m

ブーム

単位:t

Table with columns for performance block, boom length, radius, and various boom specifications (3.0m to 52.0m). Includes sections for maximum weight and extension ratio.

カウンタウエイト 47t、アウトリガ張出幅 8.0m

ブーム

単位:t

Table with columns for performance block, boom length, radius, and various boom specifications (3.0m to 52.0m). Includes sections for maximum weight and extension ratio.







カウンタウエイト 16.5t、アウトリガ張出幅 8.5m

ブーム

単位:t

Table with 28 columns (boom length 15.0m to 60.0m) and multiple rows (boom diameter 3.0m to 38.0m). Includes data for performance blocks, boom dimensions, and boom states (retracted/extended).

カウンタウエイト 16.5t、アウトリガ張出幅 8.0m

ブーム

単位:t

Table with 28 columns (boom length 15.0m to 60.0m) and multiple rows (boom diameter 3.0m to 38.0m). Includes data for performance blocks, boom dimensions, and boom states (retracted/extended).



カウンタウエイト 7.5t、アウトリガ張出幅 8.5m

ブーム

単位:t

Table with columns for performance block, boom length, radius, and various weight/extension metrics. Includes sub-tables for boom extension ratios and hook weights.

カウンタウエイト 7.5t、アウトリガ張出幅 8.0m

ブーム

単位:t

Table with columns for performance block, boom length, radius, and various weight/extension metrics. Includes sub-tables for boom extension ratios and hook weights.







# フルオートラフィングジブ

## ブーム+フルオートラフィングジブ(FLJ)作業半径-揚程図

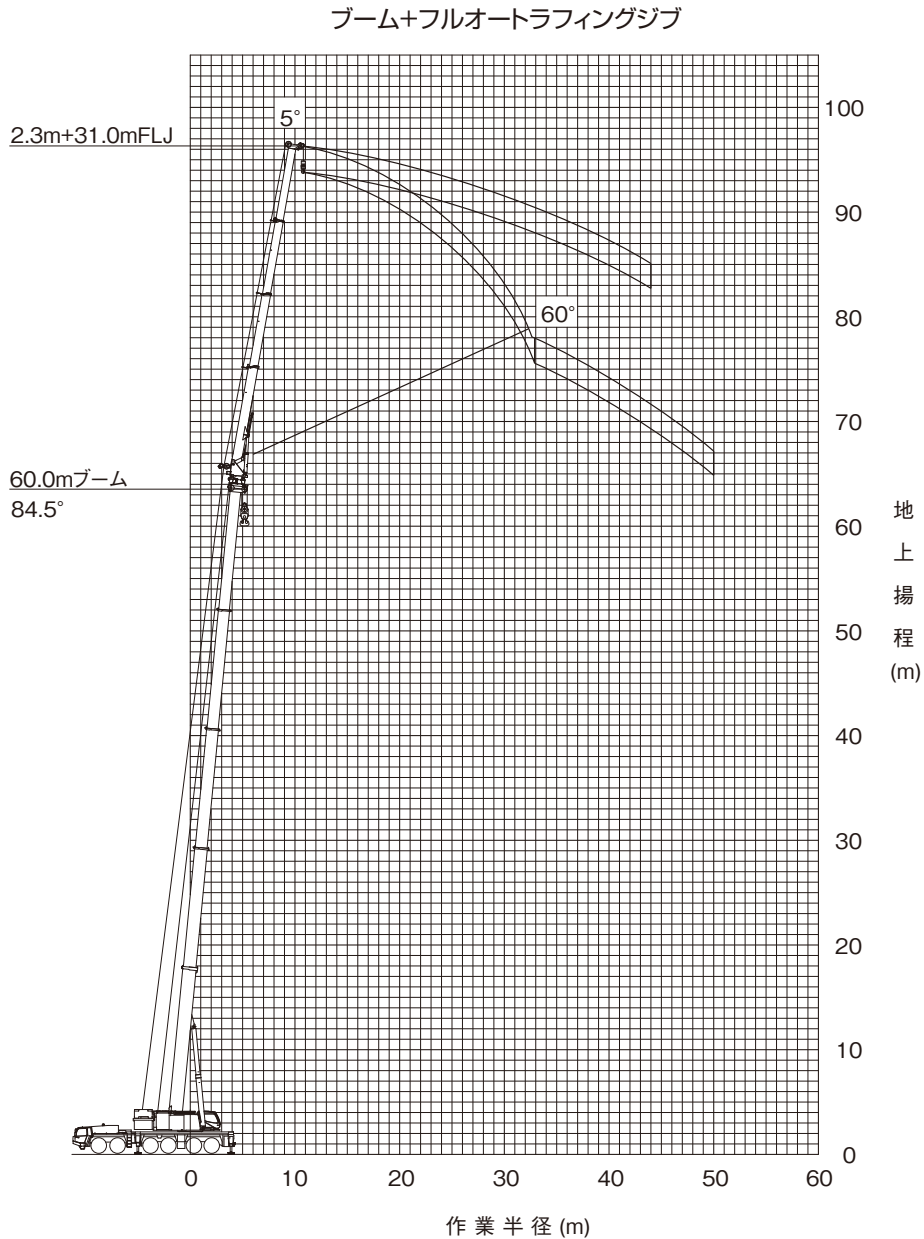

(注意)

- ◆ 上図はブームおよびジブのたわみを含んでいません。
- ◆ カウンタウエイト78t、アウトリガ張出幅8.5mの性能を図示しています。

## ブーム+フルオートラフィングジブ(FLJ)定格総荷重表

### ■ 定格総荷重表注意事項

◆性能設定のあるカウンタウエイトとアウトリガ張出幅の組合せを、下表に○印で示します。

アウトリガ張出幅 \ カウンタウエイト	78 t	58 t	47 t	25 t
8.5 m	○	○	○	○
8.0 m	○	○	○	○
6.8 m	○	○	○	

◆定格総荷重は、つり具質量とフック質量(80トンフック:1,550kg、35トンフック:950kg、12.2トンフック:440kg)を含んだ値を示します。

◆定格総荷重は、ブームとジブのたわみを含んだ実際の作業半径に基づいています。

◆各ブーム長さにおける各伸縮ブームの伸長状態(伸長割合%)は、下表のとおりです。

ブーム長さ	40.4 m	45.4 m	50.5 m	55.6 m	60.0 m
伸縮ブーム1	90	90	90	90	100
伸縮ブーム2	90	90	90	90	100
伸縮ブーム3	45	90	90	90	100
伸縮ブーム4	0	0	45	90	100

◆Bピン(ブーム固定ピン)を挿入していないときの定格総荷重は、24.9t以下になります。

◆定格総荷重表中の標準巻掛本数よりも少ない本数で使用する場合、最大荷重の上限は下表のとおりです。

巻掛本数	3本	2本	1本
最大荷重	35.9t	24.1t	12.2t

◆定格総荷重は、アウトリガを水平堅土上に設置したときの値です。

◆定格総荷重表は、風による影響を含んでいません。瞬間最大風速が10m/s以上の風速では、クレーン作業を中止してください。

#### 定格総荷重表中の線、および用語説明

◆太線より上側はクレーンの強度に、下側はクレーンの安定に基づいています。

◆「オフセット」はブームの中心線とジブの中心線とのなす角度を示します。

◆「 $\theta^\circ$ 」は、無負荷状態で作動可能なブーム起伏角度範囲を示します。



カウンタウエイト 78t、アウトリガ張出幅 8.5m  
50.5mブーム+2.3m+フルオートラフィングジブ

単位:t

ジブ長さ(m) 作業半径 (m)	10.3m オフセット					17.2m オフセット					24.1m オフセット					31.0m オフセット				
	5°	15°	30°	45°	60°	5°	15°	30°	45°	60°	5°	15°	30°	45°	60°	5°	15°	30°	45°	60°
11.0	21.2																			
12.0	20.0																			
14.0	17.8	16.8				16.5														
16.0	16.0	15.2	14.2			15.0					13.5									
18.0	14.5	13.9	13.1	12.4	11.9	13.6	12.5				12.4					9.1				
20.0	13.2	12.7	12.1	11.6	11.2	12.5	11.7				11.5					9.1				
22.0	12.1	11.6	11.1	10.7	10.5	11.4	10.8	9.8			10.7	9.6				9.1				
24.0	11.1	10.7	10.3	10.0	9.7	10.5	10.0	9.2	8.5		9.9	9.0				9.1	8.3			
26.0	10.2	9.9	9.5	9.2	9.1	9.7	9.3	8.7	8.1	7.7	9.1	8.5	7.5			8.7	7.8			
28.0	9.3	9.0	8.7	8.5	8.3	9.0	8.6	8.2	7.7	7.4	8.5	8.0	7.1			8.2	7.4			
30.0	8.3	8.1	7.8	7.6	7.5	8.2	7.9	7.6	7.4	7.1	7.8	7.5	6.8			7.7	7.0			
32.0	7.4	7.2	7.0	6.9	6.7	7.3	7.1	6.9	6.7	6.6	7.1	6.9	6.4	6.0		7.2	6.6	5.9		
34.0	6.6	6.4	6.3	6.1		6.5	6.4	6.2	6.1	6.0	6.4	6.2	6.1	5.7	5.4	6.6	6.3	5.6		
36.0	5.8	5.7	5.6	5.5		5.9	5.7	5.6	5.5	5.4	5.7	5.6	5.5	5.4	5.2	5.9	5.8	5.3		
38.0	4.2	4.8	4.9	4.9		5.2	5.1	5.0	4.9	4.9	5.1	5.0	5.0	4.9	4.8	5.3	5.3	5.1	4.7	
40.0	2.8	3.3	3.9	4.1		4.6	4.6	4.5	4.4	4.4	4.6	4.5	4.5	4.4	4.4	4.8	4.8	4.7	4.5	
42.0			2.4	2.6		3.9	4.1	4.0	4.0		4.1	4.0	4.0	4.0	3.9	4.3	4.3	4.3	4.2	4.0
44.0						2.7	3.5	3.6	3.5		3.6	3.6	3.6	3.6	3.5	3.9	3.9	3.9	3.9	3.7
46.0								3.1	3.1		3.2	3.2	3.2			3.4	3.5	3.5	3.5	3.5
48.0									2.4				2.8	2.8	2.8	3.0	3.1	3.1	3.1	3.1
50.0													2.5	2.5		2.7	2.7	2.8	2.8	2.8
54.0																	2.1	2.2	2.2	2.2
58.0																			1.6	
θ(°)	52~ 84.5	54~ 84.5	53~ 84.5	54~ 84.5	66~ 84.5	53~ 84.5	56~ 84.5	56~ 84.5	55~ 84.5	66~ 84.5	56~ 84.5	58~ 84.5	60~ 84.5	62~ 84.5	70~ 84.5	57~ 84.5	58~ 84.5	63~ 84.5	62~ 84.5	73~ 84.5
標準フック フック重量																12.2t				
標準巻掛本数																440kg				
																2				
																1				

カウンタウエイト 78t、アウトリガ張出幅 8.5m  
55.6mブーム+2.3m+フルオートラフィングジブ

単位:t

ジブ長さ(m) 作業半径 (m)	10.3m オフセット					17.2m オフセット					24.1m オフセット					31.0m オフセット				
	5°	15°	30°	45°	60°	5°	15°	30°	45°	60°	5°	15°	30°	45°	60°	5°	15°	30°	45°	60°
12.0	14.6																			
14.0	14.6	14.5																		
16.0	13.9	13.2				12.0														
18.0	12.5	12.1	11.2			11.6	10.7				9.4									
20.0	11.3	11.0	10.4	9.9	9.5	10.7	9.8				9.4					6.4				
22.0	10.3	10.0	9.6	9.2	8.9	9.8	9.1	8.3			9.3	8.5				6.4				
24.0	9.3	9.1	8.8	8.6	8.4	8.9	8.5	7.8			8.6	7.9				6.4				
26.0	8.1	8.0	7.8	7.7	7.5	8.0	7.9	7.3	6.9		8.0	7.4				6.4	6.4			
28.0	7.0	6.9	6.8	6.7	6.6	7.0	6.9	6.8	6.5	6.2	7.3	6.9	6.3			6.4	6.4			
30.0	6.1	6.0	6.0	5.9	5.8	6.1	6.1	6.1	6.0	5.9	6.5	6.5	5.9			6.4	6.0			
32.0	5.2	5.2	5.2	5.1	5.0	5.3	5.3	5.3	5.3	5.3	5.7	5.7	5.6			5.8	5.6			
34.0	4.5	4.5	4.4	4.4	4.3	4.6	4.6	4.7	4.7	4.6	5.0	5.1	4.9			5.1	5.2	4.9		
36.0	3.8	3.8	3.8	3.7	3.7	3.9	4.0	4.1	4.1	4.0	4.4	4.5	4.6	4.5	4.3	4.5	4.6	4.5		
38.0	3.1	3.1	3.2	3.1		3.3	3.4	3.5	3.5	3.5	3.8	3.9	4.0	4.1	4.0	3.9	4.1	4.1		
40.0	2.5	2.6	2.6	2.6		2.8	2.9	3.0	3.0	3.0	3.2	3.4	3.5	3.6	3.6	3.4	3.6	3.7	3.5	
42.0				2.0		2.3	2.4	2.5	2.5	2.5	2.7	2.9	3.0	3.1	3.1	3.0	3.1	3.3	3.2	
44.0							1.9	2.0	2.1		2.3	2.4	2.6	2.7	2.7	2.5	2.7	2.9	2.9	2.8
46.0								1.6	1.6		1.9	2.0	2.2	2.3	2.3	2.1	2.3	2.5	2.6	2.6
48.0												1.6	1.8	1.9		1.7	1.9	2.1	2.3	2.3
50.0														1.5			1.6	1.8	1.9	2.0
θ(°)	56~ 84.5	57~ 84.5	59~ 84.5	57~ 84.5	64~ 84.5	58~ 84.5	59~ 84.5	60~ 84.5	61~ 84.5	66~ 84.5	60~ 84.5	61~ 84.5	65~ 84.5	66~ 84.5	71~ 84.5	63~ 84.5	64~ 84.5	69~ 84.5	73~ 84.5	75~ 84.5
標準フック フック重量																12.2t				
標準巻掛本数																440kg				
																2				
																1				

FLJ

# フルオートラフィングジブ

カウンタウエイト 78t、アウトリガ張出幅 8.5m  
60.0mブーム+2.3m+フルオートラフィングジブ

単位:t

ジブ長さ(m) 作業半径 (m)	10.3m オフセット					17.2m オフセット					24.1m オフセット					31.0m オフセット					
	5°	15°	30°	45°	60°	5°	15°	30°	45°	60°	5°	15°	30°	45°	60°	5°	15°	30°	45°	60°	
14.0	12.0																				
16.0	12.0	11.6				8.0															
18.0	11.0	10.6	9.9			8.0															
20.0	9.9	9.6	9.2	8.8		8.0	8.0												5.7		
22.0	8.9	8.7	8.5	8.1	7.9	8.0	8.0												5.7		
24.0	7.7	7.7	7.6	7.5	7.3	8.0	7.7	7.2											5.7		
26.0	6.7	6.6	6.6	6.5	6.4	7.1	7.1	6.7											5.7		
28.0	5.7	5.7	5.7	5.6	5.5	6.1	6.2	6.2	5.9										5.7		
30.0	4.8	4.8	4.8	4.8	4.7	5.3	5.4	5.4	5.4	5.4	5.5	5.6	5.3					5.6	5.2		
32.0	4.0	4.1	4.1	4.1	4.0	4.5	4.6	4.7	4.8	4.7	4.7	4.9	4.9					4.9	4.9		
34.0	3.3	3.4	3.4	3.4	3.3	3.9	4.0	4.1	4.1	4.1	4.1	4.2	4.4	4.2				4.3	4.4		
36.0	2.7	2.7	2.8	2.8	2.7	3.2	3.3	3.5	3.5	3.5	3.5	3.6	3.8	3.9				3.7	3.9	3.6	
38.0	2.1	2.1	2.2	2.2		2.6	2.8	2.9	3.0	3.0	2.9	3.1	3.3	3.4	3.4			3.2	3.4	3.3	
40.0			1.7	1.7		2.1	2.3	2.4	2.5	2.5	2.4	2.6	2.8	3.0	3.0			2.7	2.9	3.0	
42.0						1.6	1.8	1.9	2.0	2.0	1.9	2.1	2.4	2.5	2.5			2.2	2.5	2.7	2.6
44.0								1.5	1.6			1.5	1.7	2.0	2.1	2.1		1.8	2.0	2.3	2.4
46.0													1.6	1.7	1.7			1.7	2.0	2.1	2.2
48.0																		1.6	1.8		1.8
50.0																					1.5
θ (°)	61~ 84.5	62~ 84.5	62~ 84.5	63~ 84.5	67~ 84.5	62~ 84.5	64~ 84.5	65~ 84.5	66~ 84.5	69~ 84.5	64~ 84.5	66~ 84.5	69~ 84.5	72~ 84.5	73~ 84.5	68~ 84.5	69~ 84.5	72~ 84.5	76~ 84.5	77~ 84.5	
標準フック	12.2t																				
フック重量	440kg																				
標準巻掛本数	1																				

カウンタウエイト 78t、アウトリガ張出幅 8.0m  
40.4mブーム+2.3m+フルオートラフィングジブ

単位:t

ジブ長さ(m) 作業半径 (m)	10.3m オフセット					17.2m オフセット					24.1m オフセット					31.0m オフセット														
	5°	15°	30°	45°	60°	5°	15°	30°	45°	60°	5°	15°	30°	45°	60°	5°	15°	30°	45°	60°										
9.0	38.4																													
10.0	36.0					16.7																								
11.0	33.8	31.6				16.7																								
12.0	31.9	30.2				16.7																								
14.0	28.6	27.3	25.2			16.7	16.7																							
16.0	25.8	24.8	23.5	22.1	21.1	16.7	16.7													10.9										
18.0	23.5	22.6	21.6	20.9	20.3	16.7	16.7	16.7												10.8										
20.0	21.5	20.8	19.9	19.4	19.0	16.7	16.7	15.9												10.5										
22.0	19.8	19.2	18.5	18.0	17.7	16.7	16.7	15.2	14.0											10.3	9.2									
24.0	18.3	17.8	17.2	16.8	16.6	16.7	16.2	14.5	13.4	12.9										10.0	8.8									
26.0	16.7	16.5	16.0	15.7	15.5	15.9	15.4	13.9	13.0	12.5	12.9	11.7	10.5							9.7	8.4									
28.0	13.5	14.4	15.0	14.7	14.6	14.8	14.4	13.3	12.5	12.1	12.5	11.4	10.1	9.3						9.2	8.1									
30.0	10.7	11.6	12.5	13.1		13.8	13.5	12.8	12.1	11.8	12.1	11.1	9.8	9.0	8.5	8.8	7.8			8.8	7.8	6.7								
32.0	8.4	9.1	9.9	10.4		11.4	12.6	12.2	11.8	11.6	11.7	10.8	9.6	8.8	8.4	8.5	7.5			8.5	7.5	6.5								
34.0	6.3	6.9	7.7	8.0		9.3	10.5	11.5	11.3	11.2	11.3	10.4	9.3	8.6	8.3	8.1	7.2			8.1	7.2	6.2								
36.0	4.5	5.1	5.7	5.9		7.4	8.5	9.8	10.7	10.6	9.6	10.0	9.0	8.5	8.2	7.8	6.9			6.9	6.1	5.5								
38.0	2.9	3.4	3.9	4.0		5.8	6.8	7.9	8.6		7.9	9.3	8.8	8.3	8.1	7.5	6.7			6.7	5.9	5.3								
40.0						4.4	5.2	6.2	6.8		6.5	7.7	8.5	8.1	8.0	7.2	6.5			7.2	6.5	5.7	5.2	5.0						
42.0						3.1	3.8	4.7	5.1		5.2	6.3	7.8	7.9		7.0	6.3			7.0	6.3	5.5	5.1	5.0						
44.0						1.9	2.6	3.3	3.6		4.0	5.0	6.3	7.2		5.9	6.1			5.9	6.1	5.4	5.0	4.9						
46.0								2.0			2.9	3.8	5.0	5.7		4.8	5.9			4.8	5.9	5.3	4.9	4.8						
48.0											1.9	2.8	3.8	4.4		3.8	5.0			3.8	5.0	5.1	4.8							
50.0												1.8	2.7	3.1		2.9	4.0			2.9	4.0	5.0	4.7							
54.0																					2.2	3.3	4.0							
θ (°)	45~ 84.5	46~ 84.5	48~ 84.5	48~ 84.5	64~ 84.5	45~ 84.5	47~ 84.5	47~ 84.5	52~ 84.5	65~ 84.5	46~ 84.5	48~ 84.5	51~ 84.5	53~ 84.5	69~ 84.5	50~ 84.5	50~ 84.5	56~ 84.5	59~ 84.5	72~ 84.5										
標準フック	80t																													
フック重量	1550kg										950kg																			
標準巻掛本数	4										2										1									

カウンタウエイト 78t、アウトリガ張出幅 8.0m  
45.4mブーム+2.3m+フルオートラフィングジブ

単位:t

ジブ長さ(m) 作業半径 (m)	10.3m オフセット					17.2m オフセット					24.1m オフセット					31.0m オフセット				
	5°	15°	30°	45°	60°	5°	15°	30°	45°	60°	5°	15°	30°	45°	60°	5°	15°	30°	45°	60°
10.0	29.5																			
11.0	27.8																			
12.0	26.3	24.5				16.7														
14.0	23.6	22.2	20.6			16.7					15.3									
16.0	21.4	20.3	19.0	18.0		16.7	16.7				14.8					10.4				
18.0	19.6	18.6	17.5	16.7	16.2	16.7	16.7				14.4					10.3				
20.0	18.0	17.2	16.2	15.6	15.1	16.4	15.4	14.3			14.0	12.8				10.1				
22.0	16.6	15.9	15.1	14.5	14.2	15.2	14.3	13.3			13.7	12.4				9.9	9.0			
24.0	15.4	14.8	14.1	13.6	13.3	14.1	13.3	12.5	11.9		13.0	12.0				9.6	8.7			
26.0	14.3	13.8	13.2	12.8	12.6	13.1	12.4	11.7	11.2	10.8	12.1	11.4	10.4			9.4	8.3			
28.0	13.4	12.9	12.4	12.0	11.9	12.2	11.6	11.0	10.5	10.2	11.3	10.7	9.9			9.2	8.0			
30.0	10.9	11.7	11.6	11.3	11.2	11.4	10.9	10.3	9.9	9.7	10.6	10.0	9.4	8.8		8.8	7.7	6.6		
32.0	8.5	9.3	10.2	10.7		10.7	10.2	9.7	9.4	9.2	9.9	9.4	8.9	8.5	8.2	8.4	7.4	6.4		
34.0	6.4	7.1	7.9	8.4		9.1	9.6	9.2	8.9	8.7	9.3	8.9	8.4	8.1	7.9	8.1	7.2	6.2		
36.0	4.6	5.3	5.9	6.3		7.3	8.4	8.7	8.4	8.3	8.8	8.4	7.9	7.7	7.5	7.8	6.9	6.0	5.5	
38.0	3.1	3.6	4.2	4.4		5.6	6.7	7.9	7.8	7.7	7.6	7.9	7.5	7.2	7.0	7.5	6.7	5.8	5.3	
40.0		2.1	2.6	2.8		4.2	5.1	6.2	7.0		6.2	7.2	6.9	6.7	6.5	7.2	6.5	5.7	5.2	5.0
42.0						2.9	3.7	4.7	5.3		4.9	6.1	6.4	6.2	6.1	6.8	6.3	5.5	5.1	4.9
44.0							2.5	3.4	3.8		3.7	4.8	5.9	5.8		5.6	6.1	5.4	5.0	4.8
46.0									2.5		2.6	3.6	4.9	5.3		4.5	5.7	5.2	4.9	4.8
48.0												2.6	3.7	4.5		3.5	4.7	5.0	4.8	4.7
50.0													2.6	3.3		2.6	3.7	4.7	4.5	
54.0																		3.2	3.9	
θ(°)	51~ 84.5	49~ 84.5	50~ 84.5	51~ 84.5	66~ 84.5	53~ 84.5	52~ 84.5	55~ 84.5	53~ 84.5	65~ 84.5	53~ 84.5	55~ 84.5	57~ 84.5	60~ 84.5	71~ 84.5	54~ 84.5	59~ 84.5	60~ 84.5	63~ 84.5	72~ 84.5
標準フック	35t					35t					12.2t									
フック重量	950kg					950kg					440kg									
標準巻掛本数	3					2					1									

カウンタウエイト 78t、アウトリガ張出幅 8.0m  
50.5mブーム+2.3m+フルオートラフィングジブ

単位:t

ジブ長さ(m) 作業半径 (m)	10.3m オフセット					17.2m オフセット					24.1m オフセット					31.0m オフセット				
	5°	15°	30°	45°	60°	5°	15°	30°	45°	60°	5°	15°	30°	45°	60°	5°	15°	30°	45°	60°
11.0	21.2																			
12.0	20.0																			
14.0	17.8	16.8				16.5														
16.0	16.0	15.2	14.2			15.0					13.5									
18.0	14.5	13.9	13.1	12.4	11.9	13.6	12.5				12.4					9.1				
20.0	13.2	12.7	12.1	11.6	11.2	12.5	11.7				11.5					9.1				
22.0	12.1	11.6	11.1	10.7	10.5	11.4	10.8	9.8			10.7	9.6				9.1				
24.0	11.1	10.7	10.3	10.0	9.7	10.5	10.0	9.2	8.5		9.9	9.0				9.1	8.3			
26.0	10.2	9.9	9.5	9.2	9.1	9.7	9.3	8.7	8.1	7.7	9.1	8.5	7.5			8.7	7.8			
28.0	9.3	9.0	8.7	8.5	8.3	9.0	8.6	8.2	7.7	7.4	8.5	8.0	7.1			8.2	7.4			
30.0	8.3	8.1	7.8	7.6	7.5	8.2	7.9	7.6	7.4	7.1	7.8	7.5	6.8			7.7	7.0			
32.0	7.4	7.2	7.0	6.9	6.7	7.3	7.1	6.9	6.7	6.6	7.1	6.9	6.4	6.0		7.2	6.6	5.9		
34.0	6.6	6.4	6.3	6.1		6.5	6.4	6.2	6.1	6.0	6.4	6.2	6.1	5.7	5.4	6.6	6.3	5.6		
36.0	4.8	5.4	5.6	5.5		5.9	5.7	5.6	5.5	5.4	5.7	5.6	5.5	5.4	5.2	5.9	5.8	5.3		
38.0	3.2	3.8	4.5	4.8		5.2	5.1	5.0	4.9	4.9	5.1	5.0	5.0	4.9	4.8	5.3	5.3	5.1	4.7	
40.0			2.9	3.2		4.3	4.6	4.5	4.4	4.4	4.6	4.5	4.5	4.4	4.4	4.8	4.8	4.7	4.5	
42.0						3.0	3.9	4.0	4.0		4.1	4.0	4.0	4.0	3.9	4.3	4.3	4.3	4.2	4.0
44.0								3.6	3.5		3.6	3.6	3.6	3.6	3.5	3.9	3.9	3.9	3.9	3.7
46.0									2.9			3.2	3.2	3.2		3.4	3.5	3.5	3.5	3.5
48.0													2.8	2.8		3.0	3.1	3.1	3.1	3.1
50.0														2.5			2.7	2.8	2.8	2.8
54.0																		2.2	2.2	
θ(°)	54~ 84.5	56~ 84.5	55~ 84.5	56~ 84.5	66~ 84.5	55~ 84.5	58~ 84.5	58~ 84.5	58~ 84.5	66~ 84.5	58~ 84.5	60~ 84.5	62~ 84.5	62~ 84.5	70~ 84.5	59~ 84.5	62~ 84.5	63~ 84.5	66~ 84.5	73~ 84.5
標準フック	35t					35t					12.2t									
フック重量	950kg					950kg					440kg									
標準巻掛本数	2					2					1									

# フルオートラフィングジブ

カウンタウエイト 78t、アウトリガ張出幅 8.0m  
55.6mブーム+2.3m+フルオートラフィングジブ

単位:t

ジブ長さ(m) 作業半径 (m)	10.3m オフセット					17.2m オフセット					24.1m オフセット					31.0m オフセット				
	5°	15°	30°	45°	60°	5°	15°	30°	45°	60°	5°	15°	30°	45°	60°	5°	15°	30°	45°	60°
12.0	14.6																			
14.0	14.6	14.5																		
16.0	13.9	13.2				12.0														
18.0	12.5	12.1	11.2			11.6	10.7				9.4									
20.0	11.3	11.0	10.4	9.9	9.5	10.7	9.8				9.4					6.4				
22.0	10.3	10.0	9.6	9.2	8.9	9.8	9.1	8.3			9.3	8.5				6.4				
24.0	9.3	9.1	8.8	8.6	8.4	8.9	8.5	7.8			8.6	7.9				6.4				
26.0	8.1	8.0	7.8	7.7	7.5	8.0	7.9	7.3	6.9		8.0	7.4				6.4	6.4			
28.0	7.0	6.9	6.8	6.7	6.6	7.0	6.9	6.8	6.5	6.2	7.3	6.9	6.3			6.4	6.4			
30.0	6.1	6.0	6.0	5.9	5.8	6.1	6.1	6.1	6.0	5.9	6.5	6.5	5.9			6.4	6.0			
32.0	5.2	5.2	5.2	5.1	5.0	5.3	5.3	5.3	5.3	5.3	5.7	5.7	5.6			5.8	5.6			
34.0	4.5	4.5	4.4	4.4	4.3	4.6	4.6	4.7	4.7	4.6	5.0	5.1	5.1	4.9		5.1	5.2	4.9		
36.0	3.8	3.8	3.8	3.7	3.7	3.9	4.0	4.1	4.1	4.0	4.4	4.5	4.6	4.5	4.3	4.5	4.6	4.5		
38.0	3.1	3.1	3.2	3.1		3.3	3.4	3.5	3.5	3.5	3.8	3.9	4.0	4.1	4.0	3.9	4.1	4.1		
40.0				2.6		2.8	2.9	3.0	3.0	3.0	3.2	3.4	3.5	3.6	3.6	3.4	3.6	3.7	3.5	
42.0							2.4	2.5	2.5	2.5	2.7	2.9	3.0	3.1	3.1	3.0	3.1	3.3	3.2	
44.0								2.0	2.1		2.3	2.4	2.6	2.7	2.7	2.5	2.7	2.9	2.9	2.8
46.0												2.0	2.2	2.3	2.3	2.1	2.3	2.5	2.6	2.6
48.0													1.8	1.9			1.9	2.1	2.3	2.3
50.0														1.5			1.6	1.8	1.9	2.0
θ (°)	58~ 84.5	59~ 84.5	61~ 84.5	60~ 84.5	64~ 84.5	60~ 84.5	61~ 84.5	62~ 84.5	64~ 84.5	66~ 84.5	62~ 84.5	63~ 84.5	65~ 84.5	66~ 84.5	71~ 84.5	64~ 84.5	64~ 84.5	69~ 84.5	73~ 84.5	75~ 84.5
標準フック			35t										12.2t							
フック重量			950kg										440kg							
標準巻掛本数			2										1							

カウンタウエイト 78t、アウトリガ張出幅 8.0m  
60.0mブーム+2.3m+フルオートラフィングジブ

単位:t

ジブ長さ(m) 作業半径 (m)	10.3m オフセット					17.2m オフセット					24.1m オフセット					31.0m オフセット				
	5°	15°	30°	45°	60°	5°	15°	30°	45°	60°	5°	15°	30°	45°	60°	5°	15°	30°	45°	60°
14.0	12.0																			
16.0	12.0	11.6				8.0														
18.0	11.0	10.6	9.9			8.0					7.1									
20.0	9.9	9.6	9.2	8.8		8.0	8.0				7.1					5.7				
22.0	8.9	8.7	8.5	8.1	7.9	8.0	8.0				7.1					5.7				
24.0	7.7	7.7	7.6	7.5	7.3	8.0	7.7	7.2			7.1	6.9				5.7				
26.0	6.7	6.6	6.6	6.5	6.4	7.1	7.1	6.7			7.1	6.6				5.7				
28.0	5.7	5.7	5.7	5.6	5.5	6.1	6.2	6.2	5.9		6.3	6.2				5.7				
30.0	4.8	4.8	4.8	4.8	4.7	5.3	5.4	5.4	5.4	5.4	5.5	5.6	5.3			5.6	5.2			
32.0	4.0	4.1	4.1	4.1	4.0	4.5	4.6	4.7	4.8	4.7	4.7	4.9	4.9			4.9	4.9			
34.0	3.3	3.4	3.4	3.4	3.3	3.9	4.0	4.1	4.1	4.1	4.1	4.2	4.4	4.2		4.3	4.4			
36.0	2.7	2.7	2.8	2.8	2.7	3.2	3.3	3.5	3.5	3.5	3.5	3.6	3.8	3.9		3.7	3.9	3.6		
38.0			2.2	2.2		2.6	2.8	2.9	3.0	3.0	2.9	3.1	3.3	3.4	3.4	3.2	3.4	3.3		
40.0						2.3	2.4	2.5	2.5	2.4	2.6	2.8	3.0	3.0	2.7	2.9	3.0			
42.0							1.9	2.0	2.0	1.9	2.1	2.4	2.5	2.5	2.2	2.5	2.7	2.6		
44.0								1.6			1.7	2.0	2.1	2.1	1.8	2.0	2.3	2.4		
46.0												1.6	1.7	1.7		1.7	2.0	2.1	2.2	
48.0																	1.6	1.8	1.8	1.8
50.0																				1.5
θ (°)	63~ 84.5	64~ 84.5	64~ 84.5	65~ 84.5	67~ 84.5	66~ 84.5	66~ 84.5	66~ 84.5	66~ 84.5	69~ 84.5	66~ 84.5	66~ 84.5	69~ 84.5	72~ 84.5	73~ 84.5	68~ 84.5	69~ 84.5	72~ 84.5	76~ 84.5	77~ 84.5
標準フック											12.2t									
フック重量											440kg									
標準巻掛本数											1									



カウンタウエイト 78t、アウトリガ張出幅 6.8m  
40.4mブーム+2.3m+フルオートラフィングジブ

単位:t

ジブ長さ(m) 作業半径 (m)	10.3m オフセット					17.2m オフセット					24.1m オフセット					31.0m オフセット				
	5°	15°	30°	45°	60°	5°	15°	30°	45°	60°	5°	15°	30°	45°	60°	5°	15°	30°	45°	60°
9.0	38.4																			
10.0	36.0					16.7														
11.0	33.8	31.6				16.7														
12.0	31.9	30.2				16.7														
14.0	28.6	27.3	25.2			16.7	16.7				16.0									
16.0	25.8	24.8	23.5	22.1	21.1	16.7	16.7				15.5					10.9				
18.0	23.5	22.6	21.6	20.9	20.3	16.7	16.7	16.7			15.0	13.5				10.8				
20.0	21.5	20.8	19.9	19.4	19.0	16.7	16.7	15.9			14.5	13.0				10.5				
22.0	19.8	19.2	18.5	18.0	17.7	16.7	16.7	15.2	14.0		13.9	12.5				10.3	9.2			
24.0	15.8	17.0	17.2	16.8	16.6	16.7	16.2	14.5	13.4	12.9	13.4	12.1	10.8			10.0	8.8			
26.0	12.4	13.4	14.8	15.6	15.5	15.6	15.4	13.9	13.0	12.5	12.9	11.7	10.5			9.7	8.4			
28.0	9.6	10.5	11.6	12.3	12.5	12.7	14.2	13.3	12.5	12.1	12.5	11.4	10.1	9.3		9.2	8.1			
30.0	7.2	8.0	8.9	9.5		10.2	11.6	12.8	12.1	11.8	12.1	11.1	9.8	9.0	8.5	8.8	7.8	6.7		
32.0	5.1	5.8	6.6	7.1		8.1	9.3	11.0	11.8	11.6	10.2	10.8	9.6	8.8	8.4	8.5	7.5	6.5		
34.0	3.3	3.9	4.6	4.9		6.2	7.4	8.8	9.9	10.3	8.4	10.0	9.3	8.6	8.3	8.1	7.2	6.2		
36.0				3.1		4.6	5.6	6.9	7.8	8.1	6.7	8.2	9.0	8.5	8.2	7.8	6.9	6.1	5.5	
38.0						3.2	4.1	5.2	5.9		5.2	6.6	8.4	8.3	8.1	7.2	6.7	5.9	5.3	
40.0							2.7	3.7	4.3		3.9	5.2	6.8	8.0	8.0	5.9	6.5	5.7	5.2	5.0
42.0								2.3	2.7		2.8	3.9	5.3	6.4		4.7	6.2	5.5	5.1	5.0
44.0												2.7	4.0	4.9		3.6	5.0	5.4	5.0	4.9
46.0													2.8	3.6		2.7	3.9	5.3	4.9	4.8
48.0																2.9	4.4	4.8		
50.0																	3.4	4.4		
θ (°)	51~ 84.5	53~ 84.5	55~ 84.5	52~ 84.5	64~ 84.5	54~ 84.5	53~ 84.5	54~ 84.5	55~ 84.5	65~ 84.5	54~ 84.5	55~ 84.5	57~ 84.5	60~ 84.5	69~ 84.5	55~ 84.5	57~ 84.5	60~ 84.5	64~ 84.5	72~ 84.5
標準フック	80t					35t					12.2t									
フック重量	1550kg					950kg					440kg									
標準巻掛本数	4					2					1									

カウンタウエイト 78t、アウトリガ張出幅 6.8m  
45.4mブーム+2.3m+フルオートラフィングジブ

単位:t

ジブ長さ(m) 作業半径 (m)	10.3m オフセット					17.2m オフセット					24.1m オフセット					31.0m オフセット				
	5°	15°	30°	45°	60°	5°	15°	30°	45°	60°	5°	15°	30°	45°	60°	5°	15°	30°	45°	60°
10.0	29.5																			
11.0	27.8																			
12.0	26.3	24.5				16.7														
14.0	23.6	22.2	20.6			16.7					15.3									
16.0	21.4	20.3	19.0	18.0		16.7	16.7				14.8					10.4				
18.0	19.6	18.6	17.5	16.7	16.2	16.7	16.7				14.4					10.3				
20.0	18.0	17.2	16.2	15.6	15.1	16.4	15.4	14.3			14.0	12.8				10.1				
22.0	16.6	15.9	15.1	14.5	14.2	15.2	14.3	13.3			13.7	12.4				9.9	9.0			
24.0	15.4	14.8	14.1	13.6	13.3	14.1	13.3	12.5	11.9		13.0	12.0				9.6	8.7			
26.0	12.5	13.6	13.2	12.8	12.6	13.1	12.4	11.7	11.2	10.8	12.1	11.4	10.4			9.4	8.3			
28.0	9.7	10.7	11.9	12.0	11.9	12.2	11.6	11.0	10.5	10.2	11.3	10.7	9.9			9.2	8.0			
30.0	7.3	8.1	9.2	9.9	10.1	10.0	10.9	10.3	9.9	9.7	10.6	10.0	9.4	8.8		8.8	7.7	6.6		
32.0	5.2	6.0	6.9	7.4		7.9	9.2	9.7	9.4	9.2	9.9	9.4	8.9	8.5	8.2	8.4	7.4	6.4		
34.0	3.4	4.1	4.9	5.3		6.0	7.3	8.8	8.9	8.7	8.1	8.9	8.4	8.1	7.9	8.1	7.2	6.2		
36.0			3.1	3.5		4.4	5.5	6.9	7.9	8.3	6.4	8.0	7.9	7.7	7.5	7.8	6.9	6.0	5.5	
38.0							4.0	5.2	6.1	6.3	5.0	6.4	7.5	7.2	7.0	6.9	6.7	5.8	5.3	
40.0								3.7	4.4		3.7	5.0	6.7	6.7	6.5	5.6	6.5	5.7	5.2	5.0
42.0												3.7	5.3	6.2	6.1	4.4	5.9	5.5	5.1	4.9
44.0													4.0	5.0		3.3	4.7	5.4	5.0	4.8
46.0														3.7			3.6	5.2	4.9	4.8
48.0																		4.3	4.8	4.7
50.0																		3.3	4.4	
θ (°)	56~ 84.5	57~ 84.5	56~ 84.5	57~ 84.5	66~ 84.5	60~ 84.5	60~ 84.5	60~ 84.5	62~ 84.5	65~ 84.5	59~ 84.5	61~ 84.5	64~ 84.5	65~ 84.5	71~ 84.5	60~ 84.5	62~ 84.5	64~ 84.5	68~ 84.5	72~ 84.5
標準フック	35t					35t					12.2t									
フック重量	950kg					950kg					440kg									
標準巻掛本数	3					2					1									

# フルオートラフィングジブ

カウンタウエイト 78t、アウトリガ張出幅 6.8m  
50.5mブーム+2.3m+フルオートラフィングジブ

単位:t

ジブ長さ(m) 作業半径 (m)	10.3m オフセット					17.2m オフセット					24.1m オフセット					31.0m オフセット					
	5°	15°	30°	45°	60°	5°	15°	30°	45°	60°	5°	15°	30°	45°	60°	5°	15°	30°	45°	60°	
11.0	21.2																				
12.0	20.0																				
14.0	17.8	16.8				16.5															
16.0	16.0	15.2	14.2			15.0					13.5										
18.0	14.5	13.9	13.1	12.4	11.9	13.6	12.5				12.4					9.1					
20.0	13.2	12.7	12.1	11.6	11.2	12.5	11.7				11.5				9.1						
22.0	12.1	11.6	11.1	10.7	10.5	11.4	10.8	9.8			10.7	9.6			9.1						
24.0	11.1	10.7	10.3	10.0	9.7	10.5	10.0	9.2	8.5		9.9	9.0			9.1	8.3					
26.0	10.2	9.9	9.5	9.2	9.1	9.7	9.3	8.7	8.1	7.7	9.1	8.5	7.5		8.7	7.8					
28.0	9.3	9.0	8.7	8.5	8.3	9.0	8.6	8.2	7.7	7.4	8.5	8.0	7.1		8.2	7.4					
30.0	7.4	8.1	7.8	7.6	7.5	8.2	7.9	7.6	7.4	7.1	7.8	7.5	6.8		7.7	7.0					
32.0	5.3	6.1	7.0	6.9	6.7	7.3	7.1	6.9	6.7	6.6	7.1	6.9	6.4	6.0	7.2	6.6	5.9				
34.0		4.3	5.1	5.6		6.1	6.4	6.2	6.1	6.0	6.4	6.2	6.1	5.7	6.6	6.3	5.6				
36.0				3.8		4.5	5.7	5.6	5.5	5.4	5.7	5.6	5.5	5.4	5.9	5.8	5.3				
38.0							4.1	5.0	4.9	4.9	4.9	5.0	5.0	4.9	5.3	5.3	5.1	4.7			
40.0								3.9	4.4	4.4		4.5	4.5	4.4	4.8	4.8	4.7	4.5			
42.0													4.0	4.0	4.3	4.3	4.3	4.2	4.0		
44.0													3.6	3.6	3.5	3.9	3.9	3.9	3.7		
46.0														3.2			3.5	3.5	3.5		
48.0																3.1	3.1	3.1	3.1		
50.0																	2.8	2.8			
θ (°)	61~ 84.5	60~ 84.5	62~ 84.5	61~ 84.5	66~ 84.5	61~ 84.5	62~ 84.5	63~ 84.5	65~ 84.5	66~ 84.5	64~ 84.5	65~ 84.5	66~ 84.5	66~ 84.5	70~ 84.5	64~ 84.5	67~ 84.5	68~ 84.5	70~ 84.5	73~ 84.5	
標準フック																12.2t					
フック重量																440kg					
標準巻掛本数																1					

カウンタウエイト 78t、アウトリガ張出幅 6.8m  
55.6mブーム+2.3m+フルオートラフィングジブ

単位:t

ジブ長さ(m) 作業半径 (m)	10.3m オフセット					17.2m オフセット					24.1m オフセット					31.0m オフセット					
	5°	15°	30°	45°	60°	5°	15°	30°	45°	60°	5°	15°	30°	45°	60°	5°	15°	30°	45°	60°	
12.0	14.6																				
14.0	14.6	14.5																			
16.0	13.9	13.2				12.0															
18.0	12.5	12.1	11.2			11.6	10.7				9.4										
20.0	11.3	11.0	10.4	9.9	9.5	10.7	9.8				9.4				6.4						
22.0	10.3	10.0	9.6	9.2	8.9	9.8	9.1	8.3			9.3	8.5			6.4						
24.0	9.3	9.1	8.8	8.6	8.4	8.9	8.5	7.8			8.6	7.9			6.4						
26.0	8.1	8.0	7.8	7.7	7.5	8.0	7.9	7.3	6.9		8.0	7.4			6.4	6.4					
28.0	7.0	6.9	6.8	6.7	6.6	7.0	6.9	6.8	6.5	6.2	7.3	6.9	6.3		6.4	6.4					
30.0	6.1	6.0	6.0	5.9	5.8	6.1	6.1	6.0	5.9	5.9	6.5	6.5	5.9		6.4	6.0					
32.0	5.2	5.2	5.2	5.1	5.0	5.3	5.3	5.3	5.3	5.3	5.7	5.7	5.6		5.8	5.6					
34.0		4.5	4.4	4.4	4.3	4.6	4.6	4.7	4.7	4.6	5.0	5.1	5.1	4.9	5.1	4.9					
36.0							4.0	4.1	4.1	4.0	4.4	4.5	4.6	4.5	4.3	4.5	4.6	4.5			
38.0								3.5	3.5	3.5	3.8	3.9	4.0	4.1	4.0	3.9	4.1	4.1			
40.0									3.0	3.0		3.4	3.5	3.6	3.6	3.4	3.6	3.7	3.5		
42.0													3.0	3.1	3.1		3.1	3.3	3.2		
44.0													2.6	2.7	2.7		2.7	2.9	2.9	2.8	
46.0														2.3	2.3			2.5	2.6	2.6	
48.0																	2.1	2.3	2.3		
50.0																		1.9	2.0		
θ (°)	64~ 84.5	63~ 84.5	65~ 84.5	66~ 84.5	67~ 84.5	66~ 84.5	67~ 84.5	68~ 84.5	68~ 84.5	68~ 84.5	66~ 84.5	68~ 84.5	68~ 84.5	70~ 84.5	71~ 84.5	69~ 84.5	69~ 84.5	71~ 84.5	73~ 84.5	75~ 84.5	
標準フック																12.2t					
フック重量																440kg					
標準巻掛本数																1					

カウンタウエイト 78t、アウトリガ張出幅 6.8m  
60.0mブーム+2.3m+フルオートラフィングジブ

単位:t

ジブ長さ(m) 作業半径 (m)	10.3m オフセット					17.2m オフセット					24.1m オフセット					31.0m オフセット				
	5°	15°	30°	45°	60°	5°	15°	30°	45°	60°	5°	15°	30°	45°	60°	5°	15°	30°	45°	60°
14.0	12.0					8.0														
16.0	12.0	11.6				8.0														
18.0	11.0	10.6	9.9									7.1								
20.0	9.9	9.6	9.2	8.8		8.0	8.0					7.1						5.7		
22.0	8.9	8.7	8.5	8.1	7.9	8.0	8.0					7.1						5.7		
24.0	7.7	7.7	7.6	7.5	7.3	8.0	7.7	7.2				7.1	6.9					5.7		
26.0	6.7	6.6	6.6	6.5	6.4	7.1	7.1	6.7				7.1	6.6					5.7		
28.0	5.7	5.7	5.7	5.6	5.5	6.1	6.2	6.2	5.9			6.3	6.2					5.7		
30.0	4.8	4.8	4.8	4.8	4.7	5.3	5.4	5.4	5.4	5.4	5.5	5.6	5.3				5.6	5.2		
32.0		4.1	4.1	4.1	4.0	4.5	4.6	4.7	4.8	4.7	4.7	4.9	4.9				4.9	4.9		
34.0					3.4	3.9	4.0	4.1	4.1	4.1	4.1	4.2	4.4	4.2			4.3	4.4		
36.0																	3.7	3.9	3.6	
38.0																	3.2	3.4	3.3	
40.0																	2.9	3.0		
42.0																	2.5	2.7	2.6	
44.0																	2.1	2.1		
46.0																		2.0	2.1	2.2
48.0																			1.8	1.8
50.0																				1.5
θ(°)	68~ 84.5	68~ 84.5	69~ 84.5	69~ 84.5	69~ 84.5	69~ 84.5	69~ 84.5	70~ 84.5	70~ 84.5	71~ 84.5	70~ 84.5	71~ 84.5	72~ 84.5	73~ 84.5	75~ 84.5	72~ 84.5	72~ 84.5	74~ 84.5	76~ 84.5	77~ 84.5
標準フック	12.2t																			
フック重量	440kg																			
標準巻掛本数	1																			

カウンタウエイト 58t、アウトリガ張出幅 8.5m  
40.4mブーム+2.3m+フルオートラフィングジブ

単位:t

ジブ長さ(m) 作業半径 (m)	10.3m オフセット					17.2m オフセット					24.1m オフセット					31.0m オフセット				
	5°	15°	30°	45°	60°	5°	15°	30°	45°	60°	5°	15°	30°	45°	60°	5°	15°	30°	45°	60°
9.0	38.4																			
10.0	36.0					16.7														
11.0	33.8	31.6				16.7														
12.0	31.9	30.2				16.7														
14.0	28.6	27.3	25.2			16.7	16.7					16.0								
16.0	25.8	24.8	23.5	22.1	21.1	16.7	16.7					15.5					10.9			
18.0	23.5	22.6	21.6	20.9	20.3	16.7	16.7	16.7				15.0	13.5				10.8			
20.0	21.5	20.8	19.9	19.4	19.0	16.7	16.7	15.9				14.5	13.0				10.5			
22.0	19.2	19.2	18.5	18.0	17.7	16.7	16.7	15.2	14.0			13.9	12.5				10.3	9.2		
24.0	15.1	16.4	17.2	16.8	16.6	16.7	16.2	14.5	13.4	12.9	13.4	12.1	10.8				10.0	8.8		
26.0	11.7	12.8	14.1	15.1	15.4	15.0	15.4	13.9	13.0	12.5	12.9	11.7	10.5				9.7	8.4		
28.0	8.8	9.8	10.9	11.7	11.9	12.0	13.7	13.3	12.5	12.1	12.5	11.4	10.1	9.3			9.2	8.1		
30.0	6.4	7.2	8.2	8.8		9.5	11.0	12.8	12.1	11.8	11.8	11.1	9.8	9.0	8.5		8.8	7.8	6.7	
32.0	4.3	5.1	5.9	6.4		7.4	8.7	10.4	11.7	11.6	9.6	10.8	9.6	8.8	8.4		8.5	7.5	6.5	
34.0			3.9	4.2		5.5	6.7	8.2	9.3	9.7	7.7	9.4	9.3	8.6	8.3		8.1	7.2	6.2	
36.0						3.9	5.0	6.3	7.2	7.5	6.1	7.6	9.0	8.5	8.2		7.8	6.9	6.1	5.5
38.0							3.4	4.6	5.3		4.6	6.0	7.8	8.3	8.1		6.7	6.7	5.9	5.3
40.0								3.1	3.6		3.3	4.6	6.2	7.5	8.0		5.3	6.5	5.7	5.0
42.0												3.3	4.8	5.9			4.1	5.6	5.5	5.0
44.0													3.5	4.4			3.1	4.4	5.4	5.0
46.0														3.0				3.4	5.1	4.9
48.0																			3.9	4.8
50.0																			2.9	3.9
θ(°)	54~ 84.5	56~ 84.5	55~ 84.5	55~ 84.5	64~ 84.5	56~ 84.5	56~ 84.5	57~ 84.5	58~ 84.5	65~ 84.5	56~ 84.5	58~ 84.5	59~ 84.5	60~ 84.5	69~ 84.5	57~ 84.5	59~ 84.5	60~ 84.5	64~ 84.5	72~ 84.5
標準フック	80t																			
フック重量	1550kg					35t					950kg					440kg				
標準巻掛本数	4					2					1					1				

# フルオートラフィングジブ

カウンタウエイト 58t、アウトリガ張出幅 8.5m  
45.4mブーム+2.3m+フルオートラフィングジブ

単位:t

ジブ長さ(m) 作業半径 (m)	10.3m オフセット					17.2m オフセット					24.1m オフセット					31.0m オフセット				
	5°	15°	30°	45°	60°	5°	15°	30°	45°	60°	5°	15°	30°	45°	60°	5°	15°	30°	45°	60°
10.0	29.5																			
11.0	27.8																			
12.0	26.3	24.5				16.7														
14.0	23.6	22.2	20.6			16.7					15.3									
16.0	21.4	20.3	19.0	18.0		16.7	16.7				14.8					10.4				
18.0	19.6	18.6	17.5	16.7	16.2	16.7	16.7				14.4					10.3				
20.0	18.0	17.2	16.2	15.6	15.1	16.4	15.4	14.3			14.0	12.8				10.1				
22.0	16.6	15.9	15.1	14.5	14.2	15.2	14.3	13.3			13.7	12.4				9.9	9.0			
24.0	15.3	14.8	14.1	13.6	13.3	14.1	13.3	12.5	11.9		13.0	12.0				9.6	8.7			
26.0	11.8	13.0	13.2	12.8	12.6	13.1	12.4	11.7	11.2	10.8	12.1	11.4	10.4			9.4	8.3			
28.0	9.0	10.0	11.2	12.0	11.9	11.8	11.6	11.0	10.5	10.2	11.3	10.7	9.9			9.2	8.0			
30.0	6.5	7.4	8.5	9.2	9.4	9.3	10.9	10.3	9.9	9.7	10.6	10.0	9.4	8.8		8.8	7.7	6.6		
32.0	4.5	5.2	6.2	6.7		7.2	8.6	9.7	9.4	9.2	9.3	9.4	8.9	8.5	8.2	8.4	7.4	6.4		
34.0			4.2	4.6		5.4	6.6	8.2	8.9	8.7	7.4	8.9	8.4	8.1	7.9	8.1	7.2	6.2		
36.0							4.9	6.3	7.3	7.7	5.8	7.4	7.9	7.7	7.5	7.8	6.9	6.0	5.5	
38.0								4.6	5.5	5.7	4.3	5.8	7.5	7.2	7.0	6.3	6.7	5.8	5.3	
40.0									3.8			4.4	6.1	6.7	6.5	5.0	6.5	5.7	5.2	5.0
42.0													4.7	5.9	6.1	3.8	5.4	5.5	5.1	4.9
44.0																4.2	5.4	5.0	4.8	
46.0																	4.9	4.9	4.8	
48.0																	3.8	4.8	4.7	
50.0																		3.9		
θ(°)	58~ 84.5	60~ 84.5	59~ 84.5	60~ 84.5	66~ 84.5	62~ 84.5	62~ 84.5	62~ 84.5	62~ 84.5	65~ 84.5	61~ 84.5	63~ 84.5	66~ 84.5	67~ 84.5	71~ 84.5	61~ 84.5	64~ 84.5	66~ 84.5	68~ 84.5	72~ 84.5
標準フック			35t							35t								12.2t		
フック重量			950kg							950kg								440kg		
標準巻掛本数			3							2								1		

カウンタウエイト 58t、アウトリガ張出幅 8.5m  
50.5mブーム+2.3m+フルオートラフィングジブ

単位:t

ジブ長さ(m) 作業半径 (m)	10.3m オフセット					17.2m オフセット					24.1m オフセット					31.0m オフセット				
	5°	15°	30°	45°	60°	5°	15°	30°	45°	60°	5°	15°	30°	45°	60°	5°	15°	30°	45°	60°
11.0	21.2																			
12.0	20.0																			
14.0	17.8	16.8				16.5														
16.0	16.0	15.2	14.2			15.0					13.5									
18.0	14.5	13.9	13.1	12.4	11.9	13.6	12.5				12.4					9.1				
20.0	13.2	12.7	12.1	11.6	11.2	12.5	11.7				11.5					9.1				
22.0	12.1	11.6	11.1	10.7	10.5	11.4	10.8	9.8			10.7	9.6				9.1				
24.0	11.1	10.7	10.3	10.0	9.7	10.5	10.0	9.2	8.5		9.9	9.0				9.1	8.3			
26.0	10.2	9.9	9.5	9.2	9.1	9.7	9.3	8.7	8.1	7.7	9.1	8.5	7.5			8.7	7.8			
28.0	9.1	9.0	8.7	8.5	8.3	9.0	8.6	8.2	7.7	7.4	8.5	8.0	7.1			8.2	7.4			
30.0	6.7	7.6	7.8	7.6	7.5	8.2	7.9	7.6	7.4	7.1	7.8	7.5	6.8			7.7	7.0			
32.0	4.6	5.4	6.4	6.9	6.7	7.3	7.1	6.9	6.7	6.6	7.1	6.9	6.4	6.0		7.2	6.6	5.9		
34.0			4.4	4.9		5.5	6.4	6.2	6.1	6.0	6.4	6.2	6.1	5.7	5.4	6.6	6.3	5.6		
36.0							5.0	5.6	5.5	5.4	5.7	5.6	5.5	5.4	5.2	5.9	5.8	5.3		
38.0								4.8	4.9	4.9		5.0	5.0	4.9	4.8	5.3	5.3	5.1	4.7	
40.0										4.4			4.5	4.4	4.4	4.8	4.8	4.7	4.5	
42.0													4.0	4.0	3.9		4.3	4.3	4.2	4.0
44.0															3.6	3.5		3.9	3.9	3.7
46.0																	3.5	3.5	3.5	
48.0																		3.1	3.1	
50.0																			2.8	
θ(°)	62~ 84.5	63~ 84.5	62~ 84.5	63~ 84.5	66~ 84.5	63~ 84.5	64~ 84.5	65~ 84.5	67~ 84.5	66~ 84.5	65~ 84.5	67~ 84.5	68~ 84.5	68~ 84.5	70~ 84.5	65~ 84.5	68~ 84.5	70~ 84.5	72~ 84.5	73~ 84.5
標準フック								35t										12.2t		
フック重量								950kg										440kg		
標準巻掛本数								2										1		

カウンタウエイト 58t、アウトリガ張出幅 8.5m  
55.6mブーム+2.3m+フルオートラフィングジブ

単位:t

ジブ長さ(m) 作業半径 (m)	10.3m オフセット					17.2m オフセット					24.1m オフセット					31.0m オフセット				
	5°	15°	30°	45°	60°	5°	15°	30°	45°	60°	5°	15°	30°	45°	60°	5°	15°	30°	45°	60°
12.0	14.6																			
14.0	14.6	14.5																		
16.0	13.9	13.2				12.0														
18.0	12.5	12.1	11.2			11.6	10.7				9.4									
20.0	11.3	11.0	10.4	9.9	9.5	10.7	9.8				9.4					6.4				
22.0	10.3	10.0	9.6	9.2	8.9	9.8	9.1	8.3			9.3	8.5				6.4				
24.0	9.3	9.1	8.8	8.6	8.4	8.9	8.5	7.8			8.6	7.9				6.4				
26.0	8.1	8.0	7.8	7.7	7.5	8.0	7.9	7.3	6.9		8.0	7.4				6.4	6.4			
28.0	7.0	6.9	6.8	6.7	6.6	7.0	6.9	6.8	6.5	6.2	7.3	6.9	6.3			6.4	6.4			
30.0	6.1	6.0	6.0	5.9	5.8	6.1	6.1	6.1	6.0	5.9	6.5	6.5	5.9			6.4	6.0			
32.0		5.2	5.2	5.1	5.0	5.3	5.3	5.3	5.3	5.3	5.7	5.7	5.6			5.8	5.6			
34.0				4.4	4.3		4.6	4.7	4.7	4.6	5.0	5.1	5.1	4.9		5.1	5.2	4.9		
36.0								4.1	4.1	4.0	4.4	4.5	4.6	4.5	4.3	4.5	4.6	4.5		
38.0									3.5	3.5		3.9	4.0	4.1	4.0	3.9	4.1	4.1		
40.0													3.5	3.6	3.6		3.6	3.7	3.5	
42.0													3.0	3.1	3.1		3.1	3.3	3.2	
44.0														2.7	2.7			2.9	2.9	2.8
46.0																		2.5	2.6	2.6
48.0																			2.3	2.3
50.0																				2.0
θ(°)	66~ 84.5	65~ 84.5	67~ 84.5	66~ 84.5	67~ 84.5	68~ 84.5	68~ 84.5	70~ 84.5	70~ 84.5	70~ 84.5	68~ 84.5	70~ 84.5	70~ 84.5	71~ 84.5	73~ 84.5	70~ 84.5	70~ 84.5	72~ 84.5	74~ 84.5	75~ 84.5
標準フック	35t										12.2t									
フック重量	950kg										440kg									
標準巻掛本数	2										1									

カウンタウエイト 58t、アウトリガ張出幅 8.5m  
60.0mブーム+2.3m+フルオートラフィングジブ

単位:t

ジブ長さ(m) 作業半径 (m)	10.3m オフセット					17.2m オフセット					24.1m オフセット					31.0m オフセット				
	5°	15°	30°	45°	60°	5°	15°	30°	45°	60°	5°	15°	30°	45°	60°	5°	15°	30°	45°	60°
14.0	12.0																			
16.0	12.0	11.6				8.0														
18.0	11.0	10.6	9.9			8.0					7.1									
20.0	9.9	9.6	9.2	8.8		8.0	8.0				7.1					5.7				
22.0	8.9	8.7	8.5	8.1	7.9	8.0	8.0				7.1					5.7				
24.0	7.7	7.7	7.6	7.5	7.3	8.0	7.7	7.2			7.1	6.9				5.7				
26.0	6.7	6.6	6.6	6.5	6.4	7.1	7.1	6.7			7.1	6.6				5.7				
28.0	5.7	5.7	5.7	5.6	5.5	6.1	6.2	6.2	5.9		6.3	6.2				5.7				
30.0		4.8	4.8	4.8	4.7	5.3	5.4	5.4	5.4	5.4	5.5	5.6	5.3			5.6	5.2			
32.0			4.1	4.1	4.0	4.5	4.6	4.7	4.8	4.7	4.7	4.9	4.9			4.9	4.9			
34.0							4.0	4.1	4.1	4.1	4.1	4.2	4.4	4.2		4.3	4.4			
36.0								3.5	3.5	3.5		3.6	3.8	3.9		3.7	3.9	3.6		
38.0									3.0	3.0			3.3	3.4	3.4		3.4	3.3		
40.0													2.8	3.0	3.0		2.9	3.0		
42.0														2.5	2.5			2.7	2.6	
44.0															2.1			2.3	2.4	
46.0																			2.1	2.2
48.0																				1.8
θ(°)	70~ 84.5	70~ 84.5	69~ 84.5	70~ 84.5	71~ 84.5	70~ 84.5	71~ 84.5	72~ 84.5	72~ 84.5	73~ 84.5	72~ 84.5	72~ 84.5	74~ 84.5	75~ 84.5	75~ 84.5	73~ 84.5	74~ 84.5	76~ 84.5	78~ 84.5	79~ 84.5
標準フック											12.2t									
フック重量											440kg									
標準巻掛本数											1									

# フルオートラフィングジブ

カウンタウエイト 58t、アウトリガ張出幅 8.0m  
40.4mブーム+2.3m+フルオートラフィングジブ

単位:t

ジブ長さ(m) 作業半径 (m)	10.3m オフセット					17.2m オフセット					24.1m オフセット					31.0m オフセット				
	5°	15°	30°	45°	60°	5°	15°	30°	45°	60°	5°	15°	30°	45°	60°	5°	15°	30°	45°	60°
9.0	38.4																			
10.0	36.0					16.7														
11.0	33.8	31.6				16.7														
12.0	31.9	30.2				16.7														
14.0	28.6	27.3	25.2			16.7	16.7				16.0									
16.0	25.8	24.8	23.5	22.1	21.1	16.7	16.7				15.5					10.9				
18.0	23.5	22.6	21.6	20.9	20.3	16.7	16.7	16.7			15.0	13.5				10.8				
20.0	21.5	20.8	19.9	19.4	19.0	16.7	16.7	15.9			14.5	13.0				10.5				
22.0	17.3	18.5	18.5	18.0	17.7	16.7	16.7	15.2	14.0		13.9	12.5				10.3	9.2			
24.0	13.3	14.6	16.1	16.8	16.6	16.6	16.2	14.5	13.4	12.9	13.4	12.1	10.8			10.0	8.8			
26.0	10.1	11.2	12.5	13.4	13.8	13.3	15.1	13.9	13.0	12.5	12.9	11.7	10.5			9.7	8.4			
28.0	7.4	8.3	9.5	10.2	10.4	10.5	12.2	13.3	12.5	12.1	12.5	11.4	10.1	9.3		9.2	8.1			
30.0	5.1	5.9	6.9	7.5		8.2	9.6	11.5	12.1	11.8	10.4	11.1	9.8	9.0	8.5	8.8	7.8	6.7		
32.0			4.7	5.1		6.2	7.5	9.1	10.4	11.0	8.4	10.2	9.6	8.8	8.4	8.5	7.5	6.5		
34.0						4.4	5.6	7.1	8.1	8.6	6.6	8.2	9.3	8.6	8.3	8.1	7.2	6.2		
36.0							3.9	5.2	6.1	6.4	5.0	6.5	8.5	8.5	8.2	7.1	6.9	6.1	5.5	
38.0								3.6	4.3		3.6	5.0	6.8	8.2	8.1	5.6	6.7	5.9	5.3	
40.0												3.6	5.3	6.5	7.1	4.4	6.0	5.7	5.2	5.0
42.0													3.9	5.0		3.3	4.7	5.5	5.1	5.0
44.0														3.6			3.6	5.4	5.0	4.9
46.0																		4.3	4.9	4.8
48.0																			3.2	4.4
50.0																				3.2
θ(°)	57~ 84.5	58~ 84.5	58~ 84.5	58~ 84.5	64~ 84.5	59~ 84.5	58~ 84.5	59~ 84.5	61~ 84.5	65~ 84.5	58~ 84.5	60~ 84.5	62~ 84.5	62~ 84.5	69~ 84.5	59~ 84.5	61~ 84.5	63~ 84.5	64~ 84.5	72~ 84.5
標準フック											35t									12.2t
フック重量											950kg									440kg
標準巻掛本数											2									1

カウンタウエイト 58t、アウトリガ張出幅 8.0m  
45.4mブーム+2.3m+フルオートラフィングジブ

単位:t

ジブ長さ(m) 作業半径 (m)	10.3m オフセット					17.2m オフセット					24.1m オフセット					31.0m オフセット				
	5°	15°	30°	45°	60°	5°	15°	30°	45°	60°	5°	15°	30°	45°	60°	5°	15°	30°	45°	60°
10.0	29.5																			
11.0	27.8																			
12.0	26.3	24.5				16.7														
14.0	23.6	22.2	20.6			16.7					15.3									
16.0	21.4	20.3	19.0	18.0		16.7	16.7				14.8					10.4				
18.0	19.6	18.6	17.5	16.7	16.2	16.7	16.7				14.4					10.3				
20.0	18.0	17.2	16.2	15.6	15.1	16.4	15.4	14.3			14.0	12.8				10.1				
22.0	16.6	15.9	15.1	14.5	14.2	15.2	14.3	13.3			13.7	12.4				9.9	9.0			
24.0	13.5	14.7	14.1	13.6	13.3	14.1	13.3	12.5	11.9		13.0	12.0				9.6	8.7			
26.0	10.2	11.3	12.8	12.8	12.6	13.1	12.4	11.7	11.2	10.8	12.1	11.4	10.4			9.4	8.3			
28.0	7.5	8.5	9.7	10.6	10.9	10.4	11.6	11.0	10.5	10.2	11.3	10.7	9.9			9.2	8.0			
30.0	5.2	6.1	7.2	7.9	8.0	8.0	9.5	10.3	9.9	9.7	10.1	10.0	9.4	8.8		8.8	7.7	6.6		
32.0			5.0	5.5		6.0	7.3	9.1	9.4	9.2	8.1	9.4	8.9	8.5	8.2	8.4	7.4	6.4		
34.0							5.5	7.0	8.2	8.7	6.3	8.0	8.4	8.1	7.9	8.1	7.2	6.2		
36.0								5.2	6.2	6.7	4.7	6.3	7.9	7.7	7.5	6.7	6.9	6.0	5.5	
38.0									4.5	4.7		4.8	6.7	7.2	7.0	5.3	6.7	5.8	5.3	
40.0													5.2	6.5	6.5		5.7	5.7	5.2	5.0
42.0														5.0	5.6		4.5	5.5	5.1	4.9
44.0																		5.3	5.0	4.8
46.0																		4.1	4.9	4.8
48.0																				4.3
θ(°)	60~ 84.5	62~ 84.5	62~ 84.5	63~ 84.5	66~ 84.5	64~ 84.5	64~ 84.5	65~ 84.5	64~ 84.5	65~ 84.5	63~ 84.5	65~ 84.5	68~ 84.5	69~ 84.5	71~ 84.5	65~ 84.5	66~ 84.5	68~ 84.5	70~ 84.5	74~ 84.5
標準フック											35t									12.2t
フック重量											950kg									440kg
標準巻掛本数											2									1



# フルオートラフィングジブ

カウンタウエイト 58t、アウトリガ張出幅 6.8m  
40.4mブーム+2.3m+フルオートラフィングジブ

単位:t

ジブ長さ(m) 作業半径 (m)	10.3m オフセット					17.2m オフセット					24.1m オフセット					31.0m オフセット				
	5°	15°	30°	45°	60°	5°	15°	30°	45°	60°	5°	15°	30°	45°	60°	5°	15°	30°	45°	60°
9.0	38.4																			
10.0	36.0					16.7														
11.0	33.8	31.6				16.7														
12.0	31.9	30.2				16.7														
14.0	28.6	27.3	25.2			16.7	16.7				16.0									
16.0	25.8	24.8	23.5	22.1	21.1	16.7	16.7				15.5					10.9				
18.0	21.7	22.6	21.6	20.9	20.3	16.7	16.7	16.7			15.0	13.5				10.8				
20.0	16.8	18.2	19.8	19.4	19.0	16.7	16.7	15.9			14.5	13.0				10.5				
22.0	12.6	13.9	15.7	16.7	17.3	15.9	16.7	15.2	14.0		13.9	12.5				10.3	9.2			
24.0	9.2	10.4	11.9	13.0	13.4	12.4	14.4	14.5	13.4	12.9	13.4	12.1	10.8			10.0	8.8			
26.0	6.4	7.4	8.7	9.6	9.9	9.5	11.3	13.5	13.0	12.5	11.8	11.7	10.5			9.7	8.4			
28.0			6.1	6.8	7.0	7.1	8.7	10.8	12.4	12.1	9.4	11.4	10.1	9.3		9.2	8.1			
30.0						5.1	6.5	8.3	9.8	10.6	7.3	9.2	9.8	9.0	8.5	8.8	7.8	6.7		
32.0							4.6	6.2	7.5	8.1	5.5	7.2	9.6	8.8	8.4	7.6	7.5	6.5		
34.0								4.4	5.4	5.8			5.5	7.7	8.6	8.3	6.0	7.2	6.2	
36.0													6.0	7.6	8.2	4.5	6.4	6.1	5.5	
38.0													4.4	5.8	6.6	5.0	5.9	5.3		
40.0														4.3	4.9		5.7	5.2	5.0	
42.0																	4.6	5.1	5.0	
44.0																		4.9	4.9	
46.0																			4.5	
θ (°)	62~ 84.5	64~ 84.5	63~ 84.5	64~ 84.5	64~ 84.5	63~ 84.5	63~ 84.5	64~ 84.5	67~ 84.5	68~ 84.5	64~ 84.5	66~ 84.5	66~ 84.5	67~ 84.5	69~ 84.5	64~ 84.5	67~ 84.5	69~ 84.5	71~ 84.5	72~ 84.5
標準フック	80t					35t					12.2t									
フック重量	1550kg					950kg					440kg									
標準巻掛本数	4					2					1									

カウンタウエイト 58t、アウトリガ張出幅 6.8m  
45.4mブーム+2.3m+フルオートラフィングジブ

単位:t

ジブ長さ(m) 作業半径 (m)	10.3m オフセット					17.2m オフセット					24.1m オフセット					31.0m オフセット				
	5°	15°	30°	45°	60°	5°	15°	30°	45°	60°	5°	15°	30°	45°	60°	5°	15°	30°	45°	60°
10.0	29.5																			
11.0	27.8																			
12.0	26.3	24.5				16.7														
14.0	23.6	22.2	20.6			16.7					15.3									
16.0	21.4	20.3	19.0	18.0		16.7	16.7				14.8					10.4				
18.0	19.6	18.6	17.5	16.7	16.2	16.7	16.7				14.4					10.3				
20.0	16.9	17.2	16.2	15.6	15.1	16.4	15.4	14.3			14.0	12.8				10.1				
22.0	12.7	14.1	15.1	14.5	14.2	15.2	14.3	13.3			13.7	12.4				9.9	9.0			
24.0	9.3	10.5	12.1	13.3	13.3	12.2	13.3	12.5	11.9		13.0	12.0				9.6	8.7			
26.0	6.5	7.6	9.0	9.9	10.4	9.4	11.2	11.7	10.8		11.5	11.4	10.4			9.4	8.3			
28.0			6.3	7.1	7.4	6.9	8.6	10.8	10.5	10.2	9.1	10.7	9.9			9.2	8.0			
30.0							6.4	8.3	9.8	9.7	7.0	9.0	9.4	8.8		8.8	7.7	6.6		
32.0								6.2	7.5	8.2		7.0	8.9	8.5	8.2	7.2	7.4	6.4		
34.0									5.5	6.1		5.3	7.6	8.1	7.9	5.6	7.2	6.2		
36.0													5.9	7.5	7.5		6.1	6.0	5.5	
38.0														5.8	6.7			5.8	5.3	
40.0															5.0			5.7	5.2	5.0
42.0																			5.1	4.9
44.0																			4.9	4.8
θ (°)	65~ 84.5	67~ 84.5	66~ 84.5	68~ 84.5	68~ 84.5	68~ 84.5	68~ 84.5	69~ 84.5	69~ 84.5	70~ 84.5	69~ 84.5	69~ 84.5	72~ 84.5	74~ 84.5	73~ 84.5	68~ 84.5	71~ 84.5	73~ 84.5	74~ 84.5	76~ 84.5
標準フック	35t					35t					12.2t									
フック重量	950kg					950kg					440kg									
標準巻掛本数	3					2					1									



カウンタウエイト 58t、アウトリガ張出幅 6.8m  
50.5mブーム+2.3m+フルオートラフィングジブ

単位:t

ジブ長さ(m) 作業半径 (m)	10.3m オフセット					17.2m オフセット					24.1m オフセット					31.0m オフセット					
	5°	15°	30°	45°	60°	5°	15°	30°	45°	60°	5°	15°	30°	45°	60°	5°	15°	30°	45°	60°	
11.0	21.2																				
12.0	20.0																				
14.0	17.8	16.8				16.5															
16.0	16.0	15.2	14.2			15.0						13.5									
18.0	14.5	13.9	13.1	12.4	11.9	13.6	12.5					12.4				9.1					
20.0	13.2	12.7	12.1	11.6	11.2	12.5	11.7					11.5				9.1					
22.0	12.1	11.6	11.1	10.7	10.5	11.4	10.8	9.8				10.7	9.6			9.1					
24.0	9.4	10.7	10.3	10.0	9.7	10.5	10.0	9.2	8.5			9.9	9.0			9.1	8.3				
26.0	6.6	7.7	9.1	9.2	9.1	9.4	9.3	8.7	8.1	7.7		9.1	8.5	7.5		8.7	7.8				
28.0			6.5	7.4	7.8	7.0	8.6	8.2	7.7	7.4		8.5	8.0	7.1		8.2	7.4				
30.0							6.5	7.6	7.4	7.1		6.9	7.5	6.8		7.7	7.0				
32.0								6.4	6.7	6.6			6.9	6.4	6.0		7.1	6.6	5.9		
34.0									5.8	6.0				6.1	5.7	5.4		6.3	5.6		
36.0														5.5	5.4	5.2		5.8	5.3		
38.0															4.9	4.8			5.1	4.7	
40.0																			4.7	4.5	
42.0																				4.2	4.0
44.0																					3.7
θ(°)	67~ 84.5	69~ 84.5	69~ 84.5	70~ 84.5	70~ 84.5	69~ 84.5	70~ 84.5	71~ 84.5	71~ 84.5	72~ 84.5	70~ 84.5	72~ 84.5	73~ 84.5	74~ 84.5	76~ 84.5	72~ 84.5	73~ 84.5	75~ 84.5	78~ 84.5	79~ 84.5	
標準フック																12.2t					
フック重量																440kg					
標準巻掛本数																1					

カウンタウエイト 58t、アウトリガ張出幅 6.8m  
55.6mブーム+2.3m+フルオートラフィングジブ

単位:t

ジブ長さ(m) 作業半径 (m)	10.3m オフセット					17.2m オフセット					24.1m オフセット					31.0m オフセット				
	5°	15°	30°	45°	60°	5°	15°	30°	45°	60°	5°	15°	30°	45°	60°	5°	15°	30°	45°	60°
12.0	14.6																			
14.0	14.6	14.5																		
16.0	13.9	13.2				12.0														
18.0	12.5	12.1	11.2			11.6	10.7					9.4								
20.0	11.3	11.0	10.4	9.9	9.5	10.7	9.8					9.4						6.4		
22.0	10.3	10.0	9.6	9.2	8.9	9.8	9.1	8.3				9.3	8.5					6.4		
24.0	9.3	9.1	8.8	8.6	8.4	8.9	8.5	7.8				8.6	7.9					6.4		
26.0		8.0	7.8	7.7	7.5	8.0	7.9	7.3	6.9			8.0	7.4					6.4	6.4	
28.0				6.7	6.6		6.9	6.8	6.5	6.2		7.3	6.9	6.3				6.4	6.4	
30.0								6.1	6.0	5.9	6.5	6.5	5.9					6.4	6.0	
32.0									5.3	5.3		5.7	5.6					5.6		
34.0										4.6			5.1	4.9				5.2	4.9	
36.0														4.5	4.3				4.5	
38.0														4.1	4.0				4.1	
40.0																				3.5
42.0																				3.2
44.0																				2.8
θ(°)	71~ 84.5	71~ 84.5	73~ 84.5	72~ 84.5	73~ 84.5	72~ 84.5	74~ 84.5	75~ 84.5	75~ 84.5	75~ 84.5	73~ 84.5	74~ 84.5	77~ 84.5	77~ 84.5	79~ 84.5	76~ 84.5	76~ 84.5	78~ 84.5	79~ 84.5	81~ 84.5
標準フック																12.2t				
フック重量																440kg				
標準巻掛本数																1				

カウンタウエイト 58t、アウトリガ張出幅 6.8m  
60.0mブーム+2.3m+フルオートラフィングジブ

単位:t

ジブ長さ(m) 作業半径 (m)	10.3m オフセット					17.2m オフセット					24.1m オフセット					31.0m オフセット					
	5°	15°	30°	45°	60°	5°	15°	30°	45°	60°	5°	15°	30°	45°	60°	5°	15°	30°			
14.0	12.0					8.0															
16.0	12.0	11.6				8.0						7.1									
18.0	11.0	10.6	9.9			8.0						7.1									
20.0	9.9	9.6	9.2	8.8		8.0	8.0					7.1						5.7			
22.0	8.9	8.7	8.5	8.1	7.9	8.0	8.0					7.1						5.7			
24.0	7.7	7.7	7.6	7.5	7.3	8.0	7.7	7.2				7.1	6.9					5.7			
26.0			6.6	6.5	6.4	7.1	7.1	6.7				7.1	6.6					5.7			
28.0					5.5		6.2	6.2	5.9			6.3	6.2					5.7			
30.0								5.4	5.4	5.4			5.6	5.3				5.6	5.2		
32.0									4.8	4.7				4.9				4.9			
34.0														4.4	4.2						
36.0															3.9					3.6	
38.0																				3.4	
θ(°)	73~ 84.5	75~ 84.5	75~ 84.5	76~ 84.5	75~ 84.5	75~ 84.5	75~ 84.5	77~ 84.5	77~ 84.5	78~ 84.5	76~ 84.5	77~ 84.5	78~ 84.5	80~ 84.5	80~ 84.5	77~ 84.5	79~ 84.5	81~ 84.5			
標準フック																			12.2t		
フック重量																			440kg		
標準巻掛本数																			1		

# フルオートラフィングジブ

カウンタウエイト 47t、アウトリガ張出幅 8.5m  
40.4mブーム+2.3m+フルオートラフィングジブ

単位:t

ジブ長さ(m) 作業半径 (m)	10.3m オフセット					17.2m オフセット					24.1m オフセット					31.0m オフセット				
	5°	15°	30°	45°	60°	5°	15°	30°	45°	60°	5°	15°	30°	45°	60°	5°	15°	30°	45°	60°
9.0	38.4																			
10.0	36.0					16.7														
11.0	33.8	31.6				16.7														
12.0	31.9	30.2				16.7														
14.0	28.6	27.3	25.2			16.7	16.7				16.0									
16.0	25.8	24.8	23.5	22.1	21.1	16.7	16.7				15.5					10.9				
18.0	23.5	22.6	21.6	20.9	20.3	16.7	16.7	16.7			15.0	13.5				10.8				
20.0	19.3	20.6	19.9	19.4	19.0	16.7	16.7	15.9			14.5	13.0				10.5				
22.0	14.7	16.2	17.7	18.0	17.7	16.7	16.7	15.2	14.0		13.9	12.5				10.3	9.2			
24.0	11.0	12.2	13.8	14.9	15.3	14.4	16.1	14.5	13.4	12.9	13.4	12.1	10.8			10.0	8.8			
26.0	7.9	9.0	10.4	11.3	11.6	11.2	13.0	13.9	13.0	12.5	12.9	11.7	10.5			9.7	8.4			
28.0	5.4	6.3	7.5	8.2	8.4	8.6	10.2	12.4	12.5	12.1	10.9	11.4	10.1	9.3		9.2	8.1			
30.0			5.0	5.6		6.3	7.8	9.7	11.2	11.8	8.6	10.6	9.8	9.0	8.5	8.8	7.8	6.7		
32.0						4.4	5.7	7.4	8.7	9.3	6.6	8.5	9.6	8.8	8.4	8.5	7.5	6.5		
34.0								5.4	6.5	7.0	5.0	6.6	8.8	8.6	8.3	7.1	7.2	6.2		
36.0									4.6	4.9		5.0	7.0	8.5	8.2	5.6	6.9	6.1	5.5	
38.0													5.4	6.8	7.6	4.2	5.9	5.9	5.3	
40.0													3.9	5.2	5.8	4.6	5.7	5.2	5.0	
42.0																	5.5	5.1	5.0	
44.0																	4.2	5.0	4.9	
46.0																		4.4	4.8	
θ (°)	59~ 84.5	61~ 84.5	60~ 84.5	62~ 84.5	64~ 84.5	61~ 84.5	63~ 84.5	64~ 84.5	64~ 84.5	65~ 84.5	62~ 84.5	64~ 84.5	64~ 84.5	67~ 84.5	69~ 84.5	62~ 84.5	65~ 84.5	67~ 84.5	69~ 84.5	72~ 84.5
標準フック	80t					35t					12.2t									
フック重量	1550kg					950kg					440kg									
標準巻掛本数	4					2					1									

カウンタウエイト 47t、アウトリガ張出幅 8.5m  
45.4mブーム+2.3m+フルオートラフィングジブ

単位:t

ジブ長さ(m) 作業半径 (m)	10.3m オフセット					17.2m オフセット					24.1m オフセット					31.0m オフセット				
	5°	15°	30°	45°	60°	5°	15°	30°	45°	60°	5°	15°	30°	45°	60°	5°	15°	30°	45°	60°
10.0	29.5																			
11.0	27.8																			
12.0	26.3	24.5				16.7														
14.0	23.6	22.2	20.6			16.7					15.3									
16.0	21.4	20.3	19.0	18.0		16.7	16.7				14.8					10.4				
18.0	19.6	18.6	17.5	16.7	16.2	16.7	16.7				14.4					10.3				
20.0	18.0	17.2	16.2	15.6	15.1	16.4	15.4	14.3			14.0	12.8				10.1				
22.0	14.9	15.9	15.1	14.5	14.2	15.2	14.3	13.3			13.7	12.4				9.9	9.0			
24.0	11.1	12.4	14.0	13.6	13.3	14.1	13.3	12.5	11.9		13.0	12.0				9.6	8.7			
26.0	8.0	9.2	10.6	11.6	12.0	11.0	12.4	11.7	11.2	10.8	12.1	11.4	10.4			9.4	8.3			
28.0		6.5	7.7	8.6	8.9	8.4	10.1	11.0	10.5	10.2	10.6	10.7	9.9			9.2	8.0			
30.0			5.3	6.0	6.2	6.1	7.7	9.7	9.9	9.7	8.3	10.0	9.4	8.8		8.8	7.7	6.6		
32.0							5.6	7.4	8.8	9.2	6.3	8.2	8.9	8.5	8.2	8.4	7.4	6.4		
34.0								5.4	6.6	7.2		6.4	8.4	8.1	7.9	6.7	7.2	6.2		
36.0													6.9	7.7	7.5	5.2	6.9	6.0	5.5	
38.0													5.3	6.8	7.0		5.7	5.8	5.3	
40.0														5.2	5.9			5.7	5.2	5.0
42.0																	5.3	5.1	4.9	
44.0																		5.0	4.8	
46.0																			4.8	
θ (°)	65~ 84.5	64~ 84.5	64~ 84.5	65~ 84.5	66~ 84.5	66~ 84.5	66~ 84.5	67~ 84.5	69~ 84.5	67~ 84.5	67~ 84.5	69~ 84.5	70~ 84.5	71~ 84.5	73~ 84.5	66~ 84.5	69~ 84.5	72~ 84.5	74~ 84.5	74~ 84.5
標準フック	35t					35t					12.2t									
フック重量	950kg					950kg					440kg									
標準巻掛本数	3					2					1									

カウンタウエイト 47t、アウトリガ張出幅 8.5m  
50.5mブーム+2.3m+フルオートラフィングジブ

単位:t

ジブ長さ(m) 作業半径	10.3m オフセット					17.2m オフセット					24.1m オフセット					31.0m オフセット				
	5°	15°	30°	45°	60°	5°	15°	30°	45°	60°	5°	15°	30°	45°	60°	5°	15°	30°	45°	60°
11.0	21.2																			
12.0	20.0																			
14.0	17.8	16.8				16.5														
16.0	16.0	15.2	14.2			15.0					13.5									
18.0	14.5	13.9	13.1	12.4	11.9	13.6	12.5				12.4					9.1				
20.0	13.2	12.7	12.1	11.6	11.2	12.5	11.7				11.5					9.1				
22.0	12.1	11.6	11.1	10.7	10.5	11.4	10.8	9.8			10.7	9.6				9.1				
24.0	11.1	10.7	10.3	10.0	9.7	10.5	10.0	9.2	8.5		9.9	9.0				9.1	8.3			
26.0	8.2	9.3	9.5	9.2	9.1	9.7	9.3	8.7	8.1	7.7	9.1	8.5	7.5			8.7	7.8			
28.0		6.6	7.9	8.5	8.3	8.5	8.6	8.2	7.7	7.4	8.5	8.0	7.1			8.2	7.4			
30.0				6.3	6.6		7.8	7.6	7.4	7.1	7.8	7.5	6.8			7.7	7.0			
32.0								6.9	6.7	6.6	6.3	6.9	6.4	6.0		7.2	6.6	5.9		
34.0									6.1	6.0		6.2	6.1	5.7	5.4	6.6	6.3	5.6		
36.0										5.4							5.8	5.3		
38.0																	5.3	5.1	4.7	
40.0																		4.7	4.5	
42.0																		4.3	4.2	4.0
44.0																			3.9	3.7
46.0																				3.5
θ(°)	67~ 84.5	67~ 84.5	69~ 84.5	68~ 84.5	68~ 84.5	69~ 84.5	70~ 84.5	71~ 84.5	71~ 84.5	70~ 84.5	69~ 84.5	70~ 84.5	73~ 84.5	72~ 84.5	74~ 84.5	70~ 84.5	72~ 84.5	73~ 84.5	76~ 84.5	77~ 84.5
標準フック	35t										12.2t									
フック重量	950kg										440kg					440kg				
標準巻掛本数	2										1					1				

カウンタウエイト 47t、アウトリガ張出幅 8.5m  
55.6mブーム+2.3m+フルオートラフィングジブ

単位:t

ジブ長さ(m) 作業半径	10.3m オフセット					17.2m オフセット					24.1m オフセット					31.0m オフセット				
	5°	15°	30°	45°	60°	5°	15°	30°	45°	60°	5°	15°	30°	45°	60°	5°	15°	30°	45°	60°
12.0	14.6																			
14.0	14.6	14.5																		
16.0	13.9	13.2				12.0														
18.0	12.5	12.1	11.2			11.6	10.7				9.4									
20.0	11.3	11.0	10.4	9.9	9.5	10.7	9.8				9.4					6.4				
22.0	10.3	10.0	9.6	9.2	8.9	9.8	9.1	8.3			9.3	8.5				6.4				
24.0	9.3	9.1	8.8	8.6	8.4	8.9	8.5	7.8			8.6	7.9				6.4				
26.0	8.1	8.0	7.8	7.7	7.5	8.0	7.9	7.3	6.9		8.0	7.4				6.4	6.4			
28.0			6.8	6.7	6.6	7.0	6.9	6.8	6.5	6.2	7.3	6.9	6.3			6.4	6.4			
30.0				5.9	5.8		6.1	6.1	6.0	5.9	6.5	6.5	5.9			6.4	6.0			
32.0								5.3	5.3	5.3		5.7	5.6			5.8	5.6			
34.0									4.7	4.6		5.1	5.1	4.9			5.2	4.9		
36.0												4.6	4.5	4.3			4.6	4.5		
38.0													4.1	4.0				4.1		
40.0														3.6				3.7	3.5	
42.0																			3.2	
44.0																				2.8
θ(°)	70~ 84.5	71~ 84.5	71~ 84.5	70~ 84.5	71~ 84.5	71~ 84.5	72~ 84.5	73~ 84.5	73~ 84.5	75~ 84.5	73~ 84.5	73~ 84.5	75~ 84.5	77~ 84.5	77~ 84.5	74~ 84.5	75~ 84.5	77~ 84.5	79~ 84.5	81~ 84.5
標準フック	35t										12.2t									
フック重量	950kg										440kg					440kg				
標準巻掛本数	2										1					1				

カウンタウエイト 47t、アウトリガ張出幅 8.5m  
60.0mブーム+2.3m+フルオートラフィングジブ

単位:t

ジブ長さ(m) 作業半径	10.3m オフセット					17.2m オフセット					24.1m オフセット					31.0m オフセット				
	5°	15°	30°	45°	60°	5°	15°	30°	45°	60°	5°	15°	30°	45°	60°	5°	15°	30°	45°	
14.0	12.0					8.0														
16.0	12.0	11.6				8.0					7.1									
18.0	11.0	10.6	9.9			8.0					7.1									
20.0	9.9	9.6	9.2	8.8		8.0	8.0				7.1							5.7		
22.0	8.9	8.7	8.5	8.1	7.9	8.0	8.0				7.1							5.7		
24.0	7.7	7.7	7.6	7.5	7.3	8.0	7.7	7.2			7.1	6.9						5.7		
26.0		6.6	6.6	6.5	6.4	7.1	7.1	6.7			7.1	6.6						5.7		
28.0				5.6	5.5	6.1	6.2	6.2	5.9		6.3	6.2						5.7		
30.0								5.4	5.4	5.4		5.6	5.3					5.6	5.2	
32.0								4.7	4.8	4.7		4.9	4.9					4.9		
34.0									4.1	4.1			4.4	4.2				4.4		
36.0													3.9							
38.0													3.4	3.4						
40.0																				
42.0																				2.6
θ(°)	73~ 84.5	73~ 84.5	75~ 84.5	74~ 84.5	75~ 84.5	74~ 84.5	75~ 84.5	75~ 84.5	75~ 84.5	77~ 84.5	76~ 84.5	75~ 84.5	78~ 84.5	78~ 84.5	80~ 84.5	77~ 84.5	78~ 84.5	80~ 84.5	81~ 84.5	
標準フック	12.2t										12.2t									
フック重量	440kg										440kg					440kg				
標準巻掛本数	1										1					1				

# フルオートラフィングジブ

カウンタウエイト 47t、アウトリガ張出幅 8.0m  
40.4mブーム+2.3m+フルオートラフィングジブ

単位:t

ジブ長さ(m) 作業半径 (m)	10.3m オフセット					17.2m オフセット					24.1m オフセット					31.0m オフセット				
	5°	15°	30°	45°	60°	5°	15°	30°	45°	60°	5°	15°	30°	45°	60°	5°	15°	30°	45°	60°
9.0	38.4																			
10.0	36.0					16.7														
11.0	33.8	31.6				16.7														
12.0	31.9	30.2				16.7														
14.0	28.6	27.3	25.2			16.7	16.7				16.0									
16.0	25.8	24.8	23.5	22.1	21.1	16.7	16.7				15.5					10.9				
18.0	22.3	22.6	21.6	20.9	20.3	16.7	16.7	16.7			15.0	13.5				10.8				
20.0	17.3	18.6	19.9	19.4	19.0	16.7	16.7	15.9			14.5	13.0				10.5				
22.0	12.9	14.3	16.0	17.1	17.6	16.2	16.7	15.2	14.0		13.9	12.5				10.3	9.2			
24.0	9.3	10.6	12.1	13.2	13.7	12.7	14.6	14.5	13.4	12.9	13.4	12.1	10.8			10.0	8.8			
26.0	6.5	7.5	8.9	9.8	10.1	9.7	11.5	13.7	13.0	12.5	12.0	11.7	10.5			9.7	8.4			
28.0			6.2	6.9	7.1	7.2	8.8	11.0	12.5	12.1	9.5	11.4	10.1	9.3		9.2	8.1			
30.0						5.1	6.6	8.5	9.9	10.7	7.4	9.3	9.8	9.0	8.5	8.8	7.8	6.7		
32.0							4.6	6.3	7.5	8.2	5.5	7.3	9.6	8.8	8.4	7.6	7.5	6.5		
34.0								4.4	5.5	5.9		5.5	7.8	8.6	8.3	6.0	7.2	6.2		
36.0													6.0	7.6	8.2	4.6	6.4	6.1	5.5	
38.0													4.5	5.9	6.7	5.0	5.9	5.3		
40.0														4.3	4.9		5.7	5.2	5.0	
42.0																	4.6	5.1	5.0	
44.0																		5.0	4.9	
46.0																			4.5	
θ(°)	62~ 84.5	64~ 84.5	63~ 84.5	64~ 84.5	64~ 84.5	63~ 84.5	63~ 84.5	64~ 84.5	67~ 84.5	68~ 84.5	64~ 84.5	66~ 84.5	66~ 84.5	67~ 84.5	69~ 84.5	64~ 84.5	67~ 84.5	69~ 84.5	71~ 84.5	72~ 84.5
標準フック	80t					35t					12.2t									
フック重量	1550kg					950kg					440kg									
標準巻掛本数	4					2					1									

カウンタウエイト 47t、アウトリガ張出幅 8.0m  
45.4mブーム+2.3m+フルオートラフィングジブ

単位:t

ジブ長さ(m) 作業半径 (m)	10.3m オフセット					17.2m オフセット					24.1m オフセット					31.0m オフセット				
	5°	15°	30°	45°	60°	5°	15°	30°	45°	60°	5°	15°	30°	45°	60°	5°	15°	30°	45°	60°
10.0	29.5																			
11.0	27.8																			
12.0	26.3	24.5				16.7														
14.0	23.6	22.2	20.6			16.7					15.3									
16.0	21.4	20.3	19.0	18.0		16.7	16.7				14.8					10.4				
18.0	19.6	18.6	17.5	16.7	16.2	16.7	16.7				14.4					10.3				
20.0	17.4	17.2	16.2	15.6	15.1	16.4	15.4	14.3			14.0	12.8				10.1				
22.0	13.0	14.5	15.1	14.5	14.2	15.2	14.3	13.3			13.7	12.4				9.9	9.0			
24.0	9.5	10.8	12.4	13.5	13.3	12.5	13.3	12.5	11.9		13.0	12.0				9.6	8.7			
26.0	6.6	7.7	9.1	10.1	10.5	9.5	11.4	11.7	11.2	10.8	11.7	11.4	10.4			9.4	8.3			
28.0			6.4	7.2	7.5	7.0	8.7	10.9	10.5	10.2	9.2	10.7	9.9			9.2	8.0			
30.0							6.4	8.4	9.9	9.7	7.1	9.1	9.4	8.8		8.8	7.7	6.6		
32.0								6.3	7.6	8.3		7.1	8.9	8.5	8.2	7.3	7.4	6.4		
34.0									5.5	6.1			7.6	8.1	7.9	5.7	7.2	6.2		
36.0													5.9	7.6	7.5		6.2	6.0	5.5	
38.0														5.9	6.8		5.8	5.3		
40.0															5.1		5.7	5.2	5.0	
42.0																		5.1	4.9	
44.0																			4.9	4.8
θ(°)	65~ 84.5	67~ 84.5	66~ 84.5	68~ 84.5	68~ 84.5	68~ 84.5	68~ 84.5	69~ 84.5	69~ 84.5	70~ 84.5	69~ 84.5	71~ 84.5	72~ 84.5	74~ 84.5	73~ 84.5	68~ 84.5	71~ 84.5	73~ 84.5	74~ 84.5	76~ 84.5
標準フック	35t					35t					12.2t									
フック重量	950kg					950kg					440kg									
標準巻掛本数	3					2					1									

カウンタウエイト 47t、アウトリガ張出幅 8.0m  
50.5mブーム+2.3m+フルオートラフィングジブ

単位:t

ジブ長さ(m) 作業半径 (m)	10.3m オフセット					17.2m オフセット					24.1m オフセット					31.0m オフセット				
	5°	15°	30°	45°	60°	5°	15°	30°	45°	60°	5°	15°	30°	45°	60°	5°	15°	30°	45°	60°
11.0	21.2																			
12.0	20.0																			
14.0	17.8	16.8				16.5														
16.0	16.0	15.2	14.2			15.0					13.5									
18.0	14.5	13.9	13.1	12.4	11.9	13.6	12.5				12.4					9.1				
20.0	13.2	12.7	12.1	11.6	11.2	12.5	11.7				11.5					9.1				
22.0	12.1	11.6	11.1	10.7	10.5	11.4	10.8	9.8			10.7	9.6				9.1				
24.0	9.6	10.7	10.3	10.0	9.7	10.5	10.0	9.2	8.5		9.9	9.0				9.1	8.3			
26.0		7.8	9.3	9.2	9.1	9.6	9.3	8.7	8.1	7.7	9.1	8.5	7.5			8.7	7.8			
28.0			6.6	7.5	7.9	7.1	8.6	8.2	7.7	7.4	8.5	8.0	7.1			8.2	7.4			
30.0								7.6	7.4	7.1	7.0	7.5	6.8			7.7	7.0			
32.0								6.4	6.7	6.6		6.9	6.4	6.0		7.2	6.6	5.9		
34.0										6.0			6.1	5.7	5.4		6.3	5.6		
36.0													5.5	5.4	5.2		5.8	5.3		
38.0														4.9	4.8				5.1	4.7
40.0																			4.7	4.5
42.0																				4.2
44.0																				3.7
θ(°)	69~ 84.5	69~ 84.5	69~ 84.5	70~ 84.5	70~ 84.5	69~ 84.5	72~ 84.5	71~ 84.5	73~ 84.5	72~ 84.5	70~ 84.5	72~ 84.5	73~ 84.5	74~ 84.5	76~ 84.5	72~ 84.5	73~ 84.5	75~ 84.5	78~ 84.5	79~ 84.5
標準フック																12.2t				
フック重量																440kg				
標準巻掛本数																1				

カウンタウエイト 47t、アウトリガ張出幅 8.0m  
55.6mブーム+2.3m+フルオートラフィングジブ

単位:t

ジブ長さ(m) 作業半径 (m)	10.3m オフセット					17.2m オフセット					24.1m オフセット					31.0m オフセット				
	5°	15°	30°	45°	60°	5°	15°	30°	45°	60°	5°	15°	30°	45°	60°	5°	15°	30°	45°	
12.0	14.6																			
14.0	14.6	14.5																		
16.0	13.9	13.2				12.0														
18.0	12.5	12.1	11.2			11.6	10.7				9.4									
20.0	11.3	11.0	10.4	9.9	9.5	10.7	9.8				9.4					6.4				
22.0	10.3	10.0	9.6	9.2	8.9	9.8	9.1	8.3			9.3	8.5				6.4				
24.0	9.3	9.1	8.8	8.6	8.4	8.9	8.5	7.8			8.6	7.9				6.4				
26.0		8.0	7.8	7.7	7.5	8.0	7.9	7.3	6.9		8.0	7.4				6.4	6.4			
28.0				6.7	6.6		6.9	6.8	6.5	6.2	7.3	6.9	6.3			6.4	6.4			
30.0								6.1	6.0	5.9		6.5	5.9			6.4	6.0			
32.0										5.3	5.3		5.7	5.6			5.6			
34.0											4.6						5.2	4.9		
36.0													5.1	4.9						
38.0														4.5	4.3					4.5
40.0														4.1	4.0					4.1
42.0																				3.5
θ(°)	71~ 84.5	71~ 84.5	73~ 84.5	72~ 84.5	73~ 84.5	72~ 84.5	74~ 84.5	75~ 84.5	75~ 84.5	75~ 84.5	74~ 84.5	74~ 84.5	77~ 84.5	77~ 84.5	79~ 84.5	76~ 84.5	76~ 84.5	78~ 84.5	79~ 84.5	79~ 84.5
標準フック																12.2t				
フック重量																440kg				
標準巻掛本数																1				

カウンタウエイト 47t、アウトリガ張出幅 8.0m  
60.0mブーム+2.3m+フルオートラフィングジブ

単位:t

ジブ長さ(m) 作業半径 (m)	10.3m オフセット					17.2m オフセット					24.1m オフセット					31.0m オフセット					
	5°	15°	30°	45°	60°	5°	15°	30°	45°	60°	5°	15°	30°	45°	60°	5°	15°	30°			
14.0	12.0					8.0															
16.0	12.0	11.6				8.0					7.1										
18.0	11.0	10.6	9.9			8.0					7.1										
20.0	9.9	9.6	9.2	8.8		8.0	8.0				7.1					5.7					
22.0	8.9	8.7	8.5	8.1	7.9	8.0	8.0				7.1					5.7					
24.0		7.7	7.6	7.5	7.3	8.0	7.7	7.2			7.1	6.9				5.7					
26.0			6.6	6.5	6.4	7.1	7.1	6.7			7.1	6.6				5.7					
28.0							6.2	6.2	5.9		6.3	6.2				5.7					
30.0								5.4	5.4	5.4		5.6	5.3				5.2				
32.0									4.8	4.7			4.9				4.9				
34.0													4.4	4.2							
36.0														3.9						3.6	
38.0																				3.4	
θ(°)	75~ 84.5	75~ 84.5	75~ 84.5	76~ 84.5	77~ 84.5	75~ 84.5	75~ 84.5	77~ 84.5	77~ 84.5	78~ 84.5	76~ 84.5	77~ 84.5	78~ 84.5	80~ 84.5	80~ 84.5	78~ 84.5	79~ 84.5	81~ 84.5	81~ 84.5	81~ 84.5	
標準フック																			12.2t		
フック重量																			440kg		
標準巻掛本数																			1		

# フルオートラフィングジブ

カウンタウエイト 47t、アウトリガ張出幅 6.8m  
40.4mブーム+2.3m+フルオートラフィングジブ

単位:t

ジブ長さ(m) 作業半径 (m)	10.3m オフセット					17.2m オフセット					24.1m オフセット					31.0m オフセット				
	5°	15°	30°	45°	60°	5°	15°	30°	45°	60°	5°	15°	30°	45°	60°	5°	15°	30°	45°	60°
9.0	38.4																			
10.0	36.0					16.7														
11.0	33.8	31.6				16.7														
12.0	31.9	30.2				16.7														
14.0	28.6	27.3	25.2			16.7	16.7				16.0									
16.0	22.7	24.4	23.5	22.1	21.1	16.7	16.7				15.5					10.9				
18.0	17.1	18.6	20.5	20.9	20.3	16.7	16.7	16.7			15.0	13.5				10.8				
20.0	12.3	13.9	15.8	17.1	17.8	15.7	16.7	15.9			14.5	13.0				10.5				
22.0	8.6	9.9	11.7	13.0	13.7	11.9	14.1	15.2	14.0		13.9	12.5				10.3	9.2			
24.0			8.3	9.4	9.8	8.8	10.8	13.3	13.4	12.9	11.2	12.1	10.8			10.0	8.8			
26.0					6.7	6.3	8.0	10.4	12.1	12.5	8.5	10.9	10.5			9.7	8.4			
28.0								7.8	9.4	10.4	6.3	8.5	10.1	9.3		8.5	8.1			
30.0								5.6	7.0	7.8		6.4	9.1	9.0	8.5	6.6	7.8	6.7		
32.0										5.5			7.0	8.8	8.4		6.5	6.5		
34.0													5.3	7.1	8.3		5.5	6.2		
36.0														5.3	6.3		6.1	5.5		
38.0																	5.2	5.3		
40.0																	5.2	5.0		
42.0																		5.0		
θ(°)	67~ 84.5	69~ 84.5	69~ 84.5	70~ 84.5	68~ 84.5	68~ 84.5	70~ 84.5	69~ 84.5	72~ 84.5	70~ 84.5	68~ 84.5	70~ 84.5	71~ 84.5	72~ 84.5	74~ 84.5	70~ 84.5	71~ 84.5	73~ 84.5	76~ 84.5	77~ 84.5
標準フック	80t					35t					12.2t									
フック重量	1550kg					950kg					440kg									
標準巻掛本数	4					2					1									

カウンタウエイト 47t、アウトリガ張出幅 6.8m  
45.4mブーム+2.3m+フルオートラフィングジブ

単位:t

ジブ長さ(m) 作業半径 (m)	10.3m オフセット					17.2m オフセット					24.1m オフセット					31.0m オフセット				
	5°	15°	30°	45°	60°	5°	15°	30°	45°	60°	5°	15°	30°	45°	60°	5°	15°	30°	45°	60°
10.0	29.5																			
11.0	27.8																			
12.0	26.3	24.5				16.7														
14.0	23.6	22.2	20.6			16.7					15.3									
16.0	21.4	20.3	19.0	18.0		16.7	16.7				14.8					10.4				
18.0	17.2	18.6	17.5	16.7	16.2	16.7	16.7				14.4					10.3				
20.0	12.5	14.1	16.0	15.6	15.1	15.6	15.4	14.3			14.0	12.8				10.1				
22.0	8.7	10.1	11.9	13.3	14.0	11.7	14.0	13.3			13.7	12.4				9.9	9.0			
24.0			8.5	9.7	10.2	8.6	10.7	12.5	11.9		10.8	12.0				9.6	8.7			
26.0					7.1		7.9	10.3	11.2	10.8	8.2	10.7	10.4			9.4	8.3			
28.0								7.7	9.5	10.2		8.3	9.9			8.2	8.0			
30.0									7.0	7.9			9.0	8.8		7.7	6.6			
32.0													6.9	8.5	8.2	6.9	6.4			
34.0														7.0	7.9		6.2			
36.0															6.4		6.0	5.5		
38.0																	5.2	5.3		
40.0																	5.2	5.0		
42.0																		4.9		
θ(°)	70~ 84.5	71~ 84.5	71~ 84.5	73~ 84.5	71~ 84.5	72~ 84.5	72~ 84.5	73~ 84.5	74~ 84.5	75~ 84.5	72~ 84.5	75~ 84.5	76~ 84.5	78~ 84.5	78~ 84.5	73~ 84.5	74~ 84.5	77~ 84.5	78~ 84.5	79~ 84.5
標準フック	35t					35t					12.2t									
フック重量	950kg					950kg					440kg									
標準巻掛本数	3					2					1									

カウンタウエイト 47t、アウトリガ張出幅 6.8m  
50.5mブーム+2.3m+フルオートラフティングジブ

単位:t

ジブ長さ(m) 作業半径 (m)	10.3m オフセット					17.2m オフセット					24.1m オフセット					31.0m オフセット			
	5°	15°	30°	45°	60°	5°	15°	30°	45°	60°	5°	15°	30°	45°	60°	5°	15°	30°	45°
11.0	21.2																		
12.0	20.0																		
14.0	17.8	16.8				16.5													
16.0	16.0	15.2	14.2			15.0					13.5								
18.0	14.5	13.9	13.1	12.4	11.9	13.6	12.5				12.4					9.1			
20.0	12.5	12.7	12.1	11.6	11.2	12.5	11.7				11.5					9.1			
22.0		10.2	11.1	10.7	10.5	11.4	10.8	9.8			10.7	9.6				9.1			
24.0			8.7	9.9	9.7		10.0	9.2	8.5		9.9	9.0				9.1	8.3		
26.0								8.7	8.1	7.7		8.5	7.5			8.7	7.8		
28.0								7.9	7.7	7.4		8.0	7.1			8.1	7.4		
30.0									7.2	7.1			6.8				7.0		
32.0															6.0				5.9
34.0															5.7	5.4			5.6
36.0																5.2			
38.0																			4.7
θ(°)	73~ 84.5	73~ 84.5	73~ 84.5	74~ 84.5	75~ 84.5	74~ 84.5	75~ 84.5	75~ 84.5	75~ 84.5	77~ 84.5	75~ 84.5	76~ 84.5	78~ 84.5	78~ 84.5	78~ 84.5	74~ 84.5	78~ 84.5	80~ 84.5	81~ 84.5
標準フック																12.2t			
フック重量																440kg			
標準巻掛本数																1			

カウンタウエイト 47t、アウトリガ張出幅 6.8m  
55.6mブーム+2.3m+フルオートラフティングジブ

単位:t

ジブ長さ(m) 作業半径 (m)	10.3m オフセット					17.2m オフセット					24.1m オフセット				31.0m オフセット			
	5°	15°	30°	45°	60°	5°	15°	30°	45°	60°	5°	15°	30°	45°	5°	15°	30°	
12.0	14.6																	
14.0	14.6	14.5																
16.0	13.9	13.2				12.0												
18.0	12.5	12.1	11.2			11.6	10.7				9.4							
20.0	11.3	11.0	10.4	9.9	9.5	10.7	9.8				9.4				6.4			
22.0		10.0	9.6	9.2	8.9	9.8	9.1	8.3			9.3	8.5			6.4			
24.0				8.6	8.4		8.5	7.8			8.6	7.9			6.4			
26.0								7.3	6.9			7.4			6.4	6.4		
28.0									6.5	6.2		6.9	6.3			6.4		
30.0										5.9			5.9			6.0		
32.0																		
34.0															4.9		4.9	
θ(°)	75~ 84.5	75~ 84.5	77~ 84.5	76~ 84.5	77~ 84.5	76~ 84.5	77~ 84.5	78~ 84.5	79~ 84.5	78~ 84.5	77~ 84.5	77~ 84.5	80~ 84.5	80~ 84.5	78~ 84.5	79~ 84.5	81~ 84.5	
標準フック																12.2t		
フック重量																440kg		
標準巻掛本数																1		

カウンタウエイト 47t、アウトリガ張出幅 6.8m  
60.0mブーム+2.3m+フルオートラフティングジブ

単位:t

ジブ長さ(m) 作業半径 (m)	10.3m オフセット					17.2m オフセット				24.1m オフセット			31.0m オフセット	
	5°	15°	30°	45°	60°	5°	15°	30°	45°	5°	15°	30°	5°	
14.0	12.0													
16.0	12.0	11.6				8.0								
18.0	11.0	10.6	9.9			8.0				7.1				
20.0	9.9	9.6	9.2	8.8		8.0	8.0			7.1			5.7	
22.0			8.5	8.1	7.9	8.0	8.0			7.1			5.7	
24.0					7.3		7.7	7.2			6.9		5.7	
26.0								6.7			6.6			
28.0									5.9					
30.0												5.3		
θ(°)	77~ 84.5	78~ 84.5	78~ 84.5	80~ 84.5	78~ 84.5	78~ 84.5	80~ 84.5	80~ 84.5	80~ 84.5	80~ 84.5	81~ 84.5	81~ 84.5		
標準フック														12.2t
フック重量														440kg
標準巻掛本数														1

# フルオートラフィングジブ

カウンタウエイト 25t、アウトリガ張出幅 8.5m  
40.4mブーム+2.3m+フルオートラフィングジブ

単位:t

ジブ長さ(m) 作業半径 (m)	10.3m オフセット					17.2m オフセット					24.1m オフセット					31.0m オフセット			
	5°	15°	30°	45°	60°	5°	15°	30°	45°	60°	5°	15°	30°	45°	60°	5°	15°	30°	45°
9.0	38.4																		
10.0	36.0					16.7													
11.0	33.8	31.6				16.7													
12.0	31.9	30.2				16.7													
14.0	27.2	27.3	25.2			16.7	16.7				16.0								
16.0	19.5	21.4	23.5	22.1	21.1	16.7	16.7				15.5					10.9			
18.0	13.8	15.7	17.7	19.3	20.3	16.7	16.7	16.7			15.0	13.5				10.8			
20.0		10.9	13.1	14.4	15.2	12.9	15.1	15.9			14.5	13.0				10.5			
22.0				10.3	11.0	9.2	11.5	14.2	14.0		11.7	12.5				10.3	9.2		
24.0							8.3	11.0	12.8	12.9	8.7	11.3	10.8			10.0	8.8		
26.0								8.1	10.0	11.0		8.6	10.5			8.5	8.4		
28.0									7.3	8.3			9.3	9.3			8.1		
30.0													7.1	9.0	8.5		7.0	6.7	
32.0														7.2	8.4			6.5	
34.0															6.5				6.2
36.0																			5.5
θ (°)	72~ 84.5	71~ 84.5	74~ 84.5	73~ 84.5	73~ 84.5	72~ 84.5	72~ 84.5	74~ 84.5	74~ 84.5	76~ 84.5	72~ 84.5	74~ 84.5	75~ 84.5	77~ 84.5	77~ 84.5	73~ 84.5	74~ 84.5	77~ 84.5	80~ 84.5
標準フック	80t					35t									12.2t				
フック重量	1550kg					950kg									440kg				
標準巻掛本数	4										2				1				

カウンタウエイト 25t、アウトリガ張出幅 8.5m  
45.4mブーム+2.3m+フルオートラフィングジブ

単位:t

ジブ長さ(m) 作業半径 (m)	10.3m オフセット					17.2m オフセット					24.1m オフセット					31.0m オフセット			
	5°	15°	30°	45°	60°	5°	15°	30°	45°	60°	5°	15°	30°	45°	60°	5°	15°	30°	45°
10.0	29.5																		
11.0	27.8																		
12.0	26.3	24.5				16.7													
14.0	23.6	22.2	20.6			16.7					15.3								
16.0	19.7	20.3	19.0	18.0		16.7	16.7				14.8					10.4			
18.0	14.0	15.9	17.5	16.7	16.2	16.7	16.7				14.4					10.3			
20.0		11.1	13.3	14.7	15.1	12.7	15.0	14.3			14.0	12.8				10.1			
22.0				10.6	11.4		11.4	13.3			11.4	12.4				9.9	9.0		
24.0								11.0	11.9			11.1				9.6	8.7		
26.0									10.0	10.8			10.4				8.3		
28.0										8.4				9.2			8.0		
30.0															8.8			6.6	
32.0																8.2			6.4
34.0																			
36.0																			5.5
θ (°)	74~ 84.5	73~ 84.5	76~ 84.5	75~ 84.5	76~ 84.5	76~ 84.5	76~ 84.5	78~ 84.5	78~ 84.5	77~ 84.5	76~ 84.5	78~ 84.5	80~ 84.5	82~ 84.5	82~ 84.5	76~ 84.5	78~ 84.5	80~ 84.5	81~ 84.5
標準フック	35t					35t									12.2t				
フック重量	950kg					950kg									440kg				
標準巻掛本数	3										2				1				



カウンタウエイト 25t、アウトリガ張出幅 8.5m

50.5mブーム+2.3m+フルオートラフティングジブ

単位:t

ジブ長さ(m) 作業半径 (m)	10.3m オフセット					17.2m オフセット					24.1m オフセット			31.0m オフセット		
	5°	15°	30°	45°	60°	5°	15°	30°	45°	60°	5°	15°	30°	5°	15°	
11.0	21.2															
12.0	20.0															
14.0	17.8	16.8				16.5										
16.0	16.0	15.2	14.2			15.0					13.5					
18.0	14.1	13.9	13.1	12.4	11.9	13.6	12.5				12.4				9.1	
20.0			12.1	11.6	11.2	12.5	11.7				11.5				9.1	
22.0				10.7	10.5		10.8	9.8				9.6			9.1	
24.0								9.2	8.5			9.0			9.1	8.3
26.0									8.1	7.7				7.5		7.8
28.0										7.4				7.1		
θ(°)	75~ 84.5	77~ 84.5	77~ 84.5	76~ 84.5	77~ 84.5	76~ 84.5	77~ 84.5	78~ 84.5	79~ 84.5	79~ 84.5	78~ 84.5	79~ 84.5	80~ 84.5	77~ 84.5	80~ 84.5	
標準フック	35t															
フック重量	950kg															
標準巻掛本数	2															

カウンタウエイト 25t、アウトリガ張出幅 8.5m

55.6mブーム+2.3m+フルオートラフティングジブ

単位:t

ジブ長さ(m) 作業半径 (m)	10.3m オフセット					17.2m オフセット				24.1m オフセット			31.0m オフセット		
	5°	15°	30°	45°	60°	5°	15°	30°	45°	5°	15°	5°	15°		
12.0	14.6														
14.0	14.6	14.5													
16.0	13.9	13.2				12.0									
18.0		12.1	11.2			11.6	10.7			9.4					
20.0			10.4	9.9	9.5		9.8			9.4			6.4		
22.0					8.9			8.3			8.5	6.4			
24.0											7.9				
26.0									6.9					6.4	
θ(°)	78~ 84.5	78~ 84.5	78~ 84.5	80~ 84.5	79~ 84.5	79~ 84.5	80~ 84.5	82~ 84.5	81~ 84.5	80~ 84.5	80~ 84.5	81~ 84.5	82~ 84.5		
標準フック	35t														
フック重量	950kg														
標準巻掛本数	2														

カウンタウエイト 25t、アウトリガ張出幅 8.5m

60.0mブーム+2.3m+フルオートラフティングジブ

単位:t

ジブ長さ(m) 作業半径 (m)	10.3m オフセット				17.2m オフセット		24.1m オフセット	31.0m オフセット
	5°	15°	30°	45°	5°	15°	5°	5°
14.0	12.0							
16.0	12.0	11.6			8.0			
18.0			9.9		8.0	7.1		
20.0				8.8	8.0		5.7	
θ(°)	80~ 84.5	81~ 84.5	82~ 84.5	81~ 84.5	82~ 84.5	83~ 84.5	83~ 84.5	
標準フック	12.2t							
フック重量	440kg							
標準巻掛本数	1							



# ラフィングジブ

## ■ ラフィングジブ(LJ)の構成

記号	名称	長さ
①	ベースジブ	11.3 m
②	ミドルAジブ	12.0 m
③	ミドルBジブ	12.0 m
④	レデューサジブ	3.0 m
⑤	ペンダントコネクタジブ	1.7 m
⑥	ミドルCジブ	6.0 m
⑦	トップジブ	6.0 m

2.5m+20.3mジブ

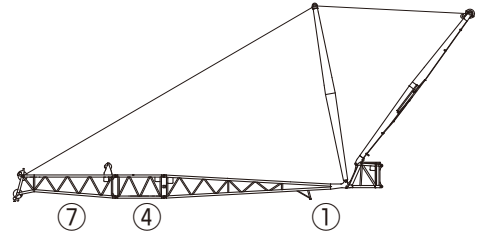

2.5m+32.3mジブ

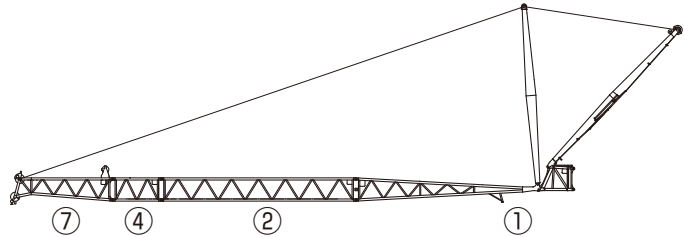

2.5m+34mジブ

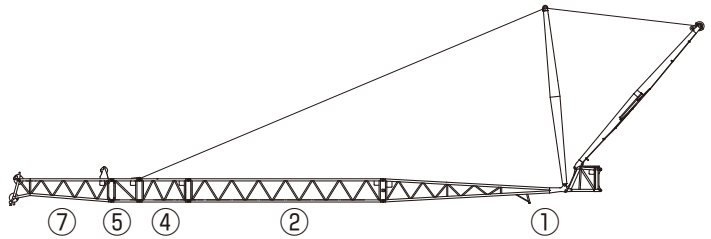

2.5m+40mジブ

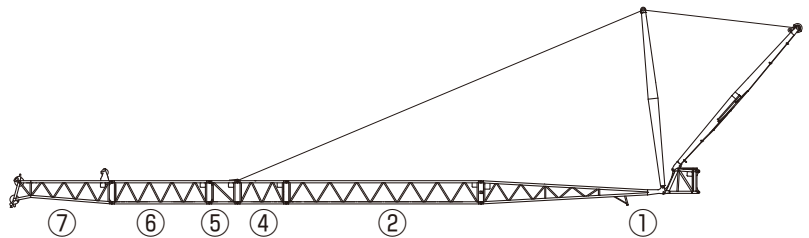

2.5m+46mジブ

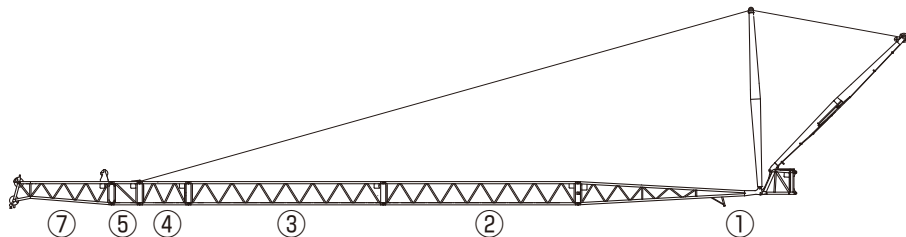

2.5m+52mジブ

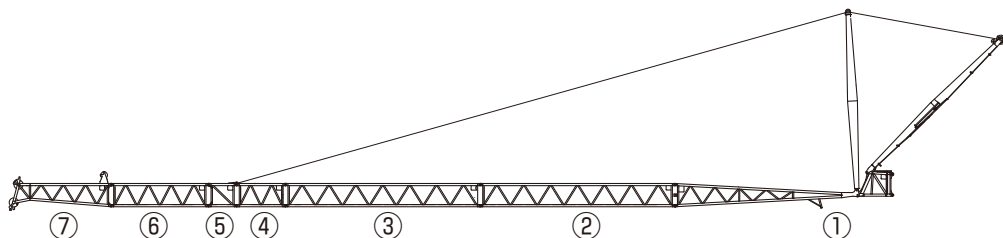

# ブーム+ラフィングジブ(LJ)作業半径-揚程図

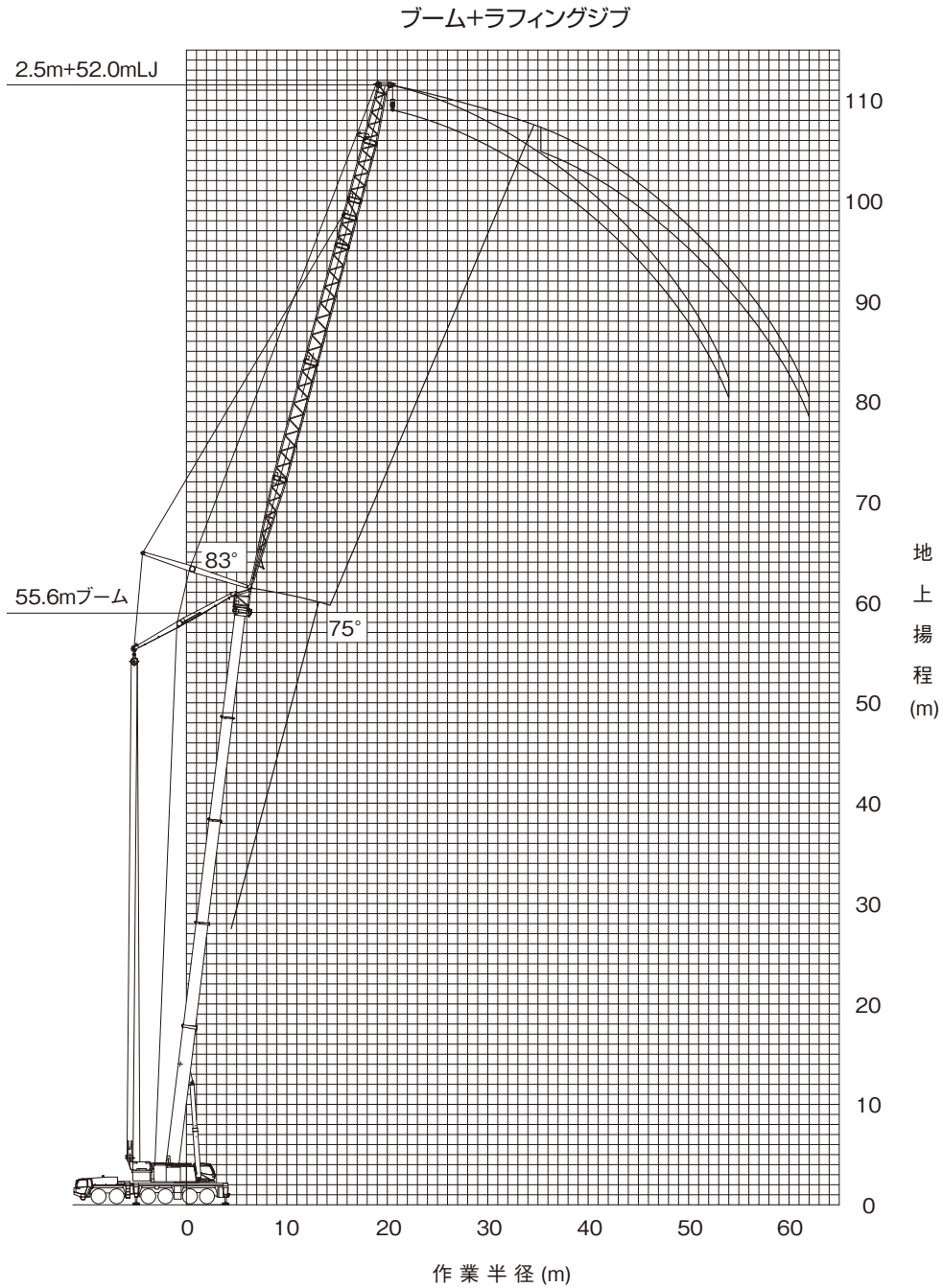

- (注意)
- ◆ 上図はブームおよびジブのたわみを含んでいません。
  - ◆ カウンタウエイト78t、アウトリガ張出幅8.5mの性能を図示しています。



# ラフィングジブ

## ブーム+ラフィングジブ(LJ)定格総荷重表

### ■ 定格総荷重表注意事項

◆性能設定のあるカウンタウエイトとアウトリガ張出幅の組合せを、下表に○印で示します。

アウトリガ張出幅 \ カウンタウエイト	78 t	58 t	47 t
8.5 m	○	○	○
8.0 m	○	○	○
6.8 m	○		

◆定格総荷重は、つり具質量とフック質量(80トンフック:1,550kg、35トンフック:950kg、12.2トンフック:440kg)を含んだ値を示します。

◆定格総荷重は、ブームのたわみを含んだ実際の作業半径に基づいています。

◆各ブーム長さにおける各伸縮ブームの伸長状態(伸長割合%)は、下表のとおりです。

ブーム長さ	15.0 m	20.1 m	25.1 m	30.2 m	35.3 m	40.4 m	45.4 m	50.5 m	55.6 m
伸縮ブーム1	0	45	90	90	90	90	90	90	90
伸縮ブーム2	0	0	0	45	90	90	90	90	90
伸縮ブーム3	0	0	0	0	0	45	90	90	90
伸縮ブーム4	0	0	0	0	0	0	0	45	90

◆Bピン(ブーム固定ピン)を挿入していない状態では使用できません。

◆定格総荷重表中の標準巻掛本数よりも少ない本数で使用する場合、最大荷重の上限は下表のとおりです。

巻掛本数	5本	4本	3本	2本	1本
最大荷重	58.6t	47.4t	35.9t	24.1t	12.2t

◆定格総荷重は、アウトリガを水平堅土上に設置したときの値です。

◆定格総荷重表は、風による影響を含んでいません。瞬間最大風速が10m/s以上の風速では、クレーン作業を中止してください。

#### 定格総荷重表中の線、および用語説明

◆太線より上側はクレーンの強度に、下側はクレーンの安定に基づいています。

◆「オフセット」は、ブームの中心線とジブの中心線とのなす角度を示します。

◆「 $\theta^\circ$ 」は、無負荷状態で作動可能なジブオフセット角度範囲を示します。









# ラフィングジブ

カウンタウエイト 78t、アウトリガ張出幅 8.0m

ブーム+2.5m+46.0mLJ

単位:t

ブーム長さ ブーム起伏角 作業半径 (m)	15.0m			20.1m			25.1m			30.2m			35.3m			40.4m			45.4m			50.5m			55.6m			
	83°	75°	68°	83°	75°	68°	83°	75°	68°	83°	75°	68°	83°	75°	68°	83°	75°	68°	83°	75°	68°	83°	75°	83°	75°			
16.0	36.7																											
18.0	35.8			30.8																								
20.0	35.1			30.2			23.7																					
22.0	34.3			29.7			23.2			18.5			17.9															
24.0	32.8			29.2			22.8			18.2			17.6															
26.0	29.4	28.1		28.3			22.4			17.9			17.4			14.9			12.9					10.1				
28.0	26.6	25.3		25.6	23.8		22.0			17.7			17.1			14.8			12.8				10.0			7.7		
30.0	24.2	23.0		23.2	21.6		21.7	19.9		17.4			16.9			14.6			12.7				9.9			7.5		
32.0	22.1	21.0	20.1	21.2	19.7		20.3	18.1		17.2	16.1		16.6			14.4			12.5				9.8			7.5		
34.0	20.4	19.3	18.5	19.5	18.1	16.5	18.7	16.6		17.0	14.8		16.4	13.6		14.3			12.3				9.7			7.4		
36.0	18.8	17.8	17.0	18.0	16.6	15.2	17.2	15.3		16.0	13.5		15.6	12.5		14.2	10.4		12.2				9.6			7.3		
38.0	17.4	16.5	15.7	16.7	15.4	14.0	15.9	14.1	12.3	14.8	12.5		14.4	11.4		13.2	9.5		12.2	8.5			9.6			7.2		
40.0	16.2	15.3	14.6	15.5	14.3	13.0	14.8	13.0	11.3	13.7	11.5	9.1	13.3	10.4		12.2	8.6		11.8	7.7			9.5	7.9		7.1		
42.0	15.1	14.2	13.6	14.4	13.3	12.0	13.7	12.1	10.5	12.8	10.7	8.3	12.3	9.6	6.8	11.3	7.8		11.0	7.0			9.1	7.2		6.9	5.8	
44.0	14.1	13.3	12.7	13.5	12.4	11.2	12.8	11.3	9.6	11.9	9.9	7.6	11.5	8.8	6.1	10.5	7.1		10.2	6.3			8.7	6.5		6.5	5.3	
46.0		12.5	11.8		11.6	10.4	12.0	10.5	8.9	11.2	9.1	6.9	10.7	8.1	5.6	9.8	6.5	3.7	9.4	5.8			8.2	5.9		6.1	4.7	
48.0		11.7	11.1		10.8	9.7		9.8	8.2		8.4	6.3		7.4	5.0		5.9	3.3	8.7	5.2	2.3		7.7	5.4		5.7	4.2	
50.0						9.1		9.1	7.6		7.8	5.8		6.8	4.5		5.4	2.9		4.7	1.9			4.9	1.8		5.4	3.8
54.0									6.5			6.5		5.8	3.7		4.5	2.2		3.8				4.0			3.0	
58.0													2.9				1.5							3.2			2.3	
θ (°)	8~62	8~61	8~46	8~60	8~55	8~46	8~65	8~58	8~55	8~62	8~53	8~47	8~60	8~66	8~56	8~58	8~58	8~47	8~63	8~53	8~24	8~61	8~66	8~21	8~66	8~58		
標準フック	80t			35t												12.2t												
フック質量	1550kg			950kg												440kg												
標準巻掛本数	4			3						2						1												



# ラフィングジブ

カウンタウエイト 78t、アウトリガ張出幅 6.8m  
 ブーム+2.5m+46.0mLJ

ブーム長さ 作業半径 (m)	15.0m			20.1m			25.1m			30.2m			35.3m			40.4m			45.4m			50.5m			55.6m					
	83°	75°	68°	83°	75°	68°	83°	75°	68°	83°	75°	68°	83°	75°	68°	83°	75°	68°	83°	75°	68°	83°	75°	68°	83°	75°	68°			
16.0	36.7																													
18.0	35.8			30.8																										
20.0	35.1			30.2			23.7																							
22.0	31.6			29.7			23.2			18.5			17.9																	
24.0	28.1			26.9			22.8			18.2			17.6																	
26.0	25.2	23.8		24.1			22.4			17.9			17.4			14.9						12.9			10.1					
28.0	22.8	21.5		21.8	20.0		20.7			17.7			17.1			14.8						12.8			10.0			7.7		
30.0	20.7	19.5		19.8	18.1		18.8	16.4		17.4			16.8			14.6						12.7			9.9			7.5		
32.0	19.0	17.8	17.0	18.1	16.5		17.2	15.0		15.9	13.0		15.3			14.0						12.5			9.8			7.5		
34.0	17.4	16.3	15.5	16.6	15.1	13.6	15.7	13.7		14.5	11.9		14.0	10.5		12.7						12.3			9.7			7.4		
36.0	16.1	15.1	14.3	15.3	13.9	12.5	14.5	12.6		13.3	10.8		12.9	9.5		11.7	7.5					11.2			9.6			7.3		
38.0	14.9	13.9	13.2	14.1	12.8	11.5	13.4	11.6	9.6	12.3	9.8		11.8	8.6		10.7	6.7					10.2	5.8		9.6			7.2		
40.0	13.8	12.9	12.2	13.1	11.9	10.6	12.4	10.7	8.7	11.4	9.0	6.4	10.9	7.8		9.8	6.0					9.4	5.1	9.5	5.3			7.1		
42.0	12.9	12.0	11.3	12.2	11.0	9.8	11.5	9.9	8.0	10.5	8.2	5.8	10.1	7.1	4.3	9.0	5.4					8.5	4.5	9.1	4.7	6.9		3.4		
44.0	12.0	11.2	10.5	11.4	10.3	9.1	10.7	9.2	7.3	9.8	7.5	5.2	9.4	6.4	3.8	8.2	4.8					7.8	4.0	8.3	4.2	6.5		3.0		
46.0		10.5	9.8		9.5	8.4	10.0	8.5	6.6	9.2	6.8	4.7	8.7	5.8	3.3	7.6	4.3	1.5				7.2	3.5	7.6	3.7	6.1		2.5		
48.0		9.8	9.2		8.9	7.7		7.8	6.1		6.3	4.2		5.3	2.9		3.8					6.6	3.1	7.0	3.3	5.7		2.2		
50.0						7.1		7.2	5.5		5.7	3.8		4.8	2.5		3.4						6.2	2.7		2.9	5.4		1.8	
54.0								4.6			4.6		3.0		3.9	1.8		2.6						2.0			2.2			
58.0																											1.5			
θ (°)	8~62	8~61	8~46	8~60	8~55	8~46	8~65	8~58	8~55	8~62	8~53	8~47	8~60	8~66	8~41	8~58	8~58	8~20	8~63	8~53	8~61	8~66	8~66	8~36						
標準フック	80t			35t												12.2t														
フック質量	1550kg			950kg												440kg														
標準巻掛本数	4			3			2						1																	







# ラフィングジブ

カウンタウエイト 47t、アウトリガ張出幅 8.0m  
 ブーム+2.5m+20.3mLJ

ブーム長さ ブーム起伏角 作業半径 (m)	15.0m			20.1m			25.1m			30.2m			35.3m			40.4m			45.4m			単位 : t
	83°	75°	68°	83°	75°	68°	83°	75°	68°	83°	75°	68°	83°	75°	68°	83°	75°	68°	83°	75°	68°	
12.0	67.7																					
14.0	53.7			51.9			50.0															
16.0	44.4	42.4		42.9			41.3			39.9												
18.0	37.8	36.0		36.5	33.6		35.1			33.8			32.4			30.9						
20.0	32.7	31.1	29.7	31.6	29.1		30.3	27.0		29.2			28.0			26.7					25.8	
22.0		27.4	26.1		25.5			23.7		25.6	22.2		24.6			23.4					22.6	
24.0			23.6		22.7	21.1		21.2		19.7			18.0			16.1					20.0	
26.0					18.9			19.0	16.6		17.6					14.6						
28.0									15.0			13.3		14.5			13.1					
30.0												12.0			10.3		11.8				10.7	
32.0															9.3							
34.0																				6.6		
36.0																						4.5
θ (°)	18~62	18~51	18~44	18~57	18~57	18~45	18~53	18~68	18~46	18~63	18~52	18~47	18~58	18~57	18~47	18~54	18~67	18~48	18~64	18~52	18~49	
標準フック	80t																					
フック質量	1550kg																					
標準巻掛本数	6			5			4			3			2			1						

カウンタウエイト 47t、アウトリガ張出幅 8.0m  
 ブーム+2.5m+32.3mLJ

ブーム長さ ブーム起伏角 作業半径 (m)	15.0m			20.1m			25.1m			30.2m			35.3m			40.4m			45.4m			50.5m		単位 : t
	83°	75°	68°	83°	75°	68°	83°	75°	68°	83°	75°	68°	83°	75°	68°	83°	75°	68°	83°	75°	83°	75°		
12.0	58.6																							
14.0	52.1			47.4			43.5																	
16.0	42.8			41.1			39.2			37.6														
18.0	36.1			34.7			33.1			31.7			30.0											
20.0	31.2	29.6		29.9	27.4		28.5			27.2			25.8			22.5								
22.0	27.3	25.9		26.2	23.9		24.9	21.8		23.8			22.5			21.3				17.8		13.7		
24.0	24.3	22.9	21.7	23.2	21.1		22.0	19.3		21.0	17.5		19.9			18.8				17.5		13.7		
26.0	21.8	20.5	19.4	20.8	18.8		17.1	19.7	17.2		18.7	15.5		17.7			16.8			15.6		13.7		
28.0	19.7	18.4	17.5	18.8	16.9	15.4	17.7	15.4		16.8	13.9		15.9	12.3		15.1				14.0		13.5		
30.0	17.9	16.7	15.8	17.0	15.3	13.9	16.1	14.0	11.7	15.3	12.6		14.4	11.1		13.6	9.3			12.6		12.4		
32.0		15.3	14.6	15.6	14.0	12.7	14.7	12.7	10.6	13.9	11.4	8.7	13.1	10.0		12.4	8.3			11.5	6.6	11.2		
34.0			14.0	13.4		12.8	11.6		11.6	9.6		10.4	7.8	11.9	9.0	5.7	11.3	7.5			10.4	5.9	10.2	5.2
36.0				12.3		11.9	10.6		10.6	8.8		9.5	7.0		8.2	5.0		6.7			9.2	9.3	4.6	
38.0							9.7		9.7	8.0		8.7	6.3		7.4	4.5		6.0	2.7			4.6	4.1	
40.0										7.3			5.7		6.7	3.9		5.4	2.3			4.1	3.6	
42.0													5.1			3.5		4.8	1.9			3.6	2.7	
44.0																3.0			1.6				2.7	
θ (°)	8~56	8~56	8~49	8~63	8~61	8~50	8~60	8~68	8~51	8~57	8~57	8~51	8~64	8~61	8~52	8~60	8~69	8~42	8~58	8~57	8~65	8~62		
標準フック	80t																							
フック質量	1550kg																							
標準巻掛本数	5			4			3			2			1											